

**DATA SHEET**

# SKY13318-321LF: PHEMT GaAs IC High-Power 4-CTL DPDT Switch LF-6 GHz

**Features**

- Application 802.11a (5.2–5.8 GHz) and 802.11b, (2.4 GHz) diversity
- Operating frequency LF-6 GHz
- Positive low voltage control (0/3 V operation)
- Low insertion loss, less than 1.2 dB, LF-6 GHz
- High linearity 57 dBm IIP3
- Miniature QFN-12 3 x 3 x 0.75 mm plastic package
- Available lead (Pb)-free, RoHS-compliant, and Green™, MSL-1 @ 260 °C per JEDEC J-STD-020

**Description**

Skyworks SKY13318-321LF is a broadband DPDT switch designed to combine T/R and antenna diversity switching functions on a single IC. The device is designed to handle high power and maintain high linearity at low control voltages. This-low cost switch is ideal for Wi-Fi systems and is capable of covering both the 2.4 GHz and 5 GHz bands.

**Pin Out (Top View)**

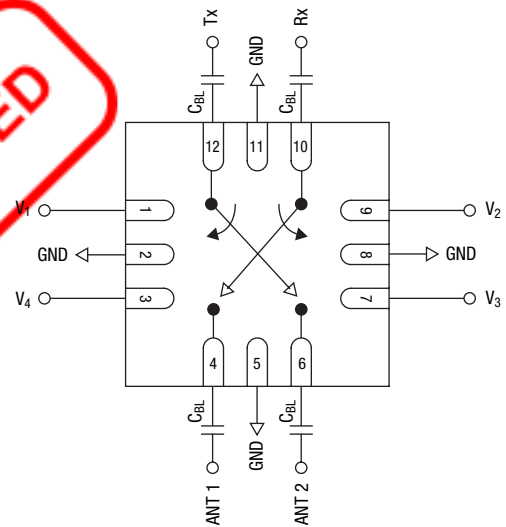

DC blocking caps ( $C_{BL}$ ) must be supplied externally.  
 $C_{BL} = 15 \text{ pF}$  for operation  $> 2 \text{ GHz}$ .

**NEW**



Skyworks Green™ products are RoHS (Restriction of Hazardous Substances)-compliant, conform to the EIA/EICTA/JEITA Joint Industry Guide (JIG) Level A guidelines, are halogen free according to IEC-61249-2-21, and contain  $< 1,000 \text{ ppm}$  antimony trioxide in polymeric materials.

**Electrical Specifications at 25 °C (0, 3 V)**

Parameter <sup>(1, 4)</sup>	Condition	Frequency	Min.	Typ.	Max.	Unit
Insertion loss <sup>(2)</sup>	Between any pair of ports	2.4–2.5 GHz		0.95	1.1	dB
		5.0–6.0 GHz		1.15	1.3	dB
Isolation	A1–Tx, A2–Rx, A2–Tx, or A1–Rx	2.4–2.5 GHz	20	22		dB
		5.0–6.0 GHz	13	15		dB
	A1–A2 or Tx–Rx	2.4–2.5 GHz	20	22		dB
		5.0–6.0 GHz	15	17		dB
Return loss <sup>(3)</sup>		2.4–2.5 GHz		24		dB
		5.0–6.0 GHz		18		dB

1. All measurements made in a 50 Ω system.  
 2. Insertion loss changes by 0.003 dB/C.

3. Return loss for insertion loss state.  
 4. Tx and Rx paths can be used interchangeably.

**Operating Characteristics at 25 °C (0, 3 V)**

Parameter	Condition	Frequency	Min.	Typ.	Max.	Unit
Switching characteristics						
Rise, fall	10/90% or 90/10% RF)			20		ns
On, off	50% CTL to 90/10% RF)			50		ns
Video feedthru				50		mV
IIP3	V <sub>CTL</sub> = 0/3 V	2.4 GHz		57		dBm
		5.2 GHz		56		dBm
	V <sub>CTL</sub> = 0/5 V	2.4 GHz		60		dBm
		5.2 GHz		57		dBm
P <sub>1</sub> dB	V <sub>CTL</sub> = 0/3 V	2.4–5.875 GHz		34		dBm
Gate leakage current	V <sub>CTL</sub> = 0/3 V			10		μA
Thermal resistance				25		°C/W
Control voltages			2.5	3	5	V

**Absolute Maximum Ratings**

Characteristic	Value
RF input power	35 dBm > 500 MHz 0/7 V control
Control voltage	0.2 V, +8 V
Operating temperature	-40 °C to +85 °C
Storage temperature	-65 °C to +150 °C

**Truth Table**

V <sub>1</sub>	V <sub>2</sub>	V <sub>3</sub>	V <sub>4</sub>	A1-Tx	A2-Rx	A2-Tx	A1-Rx
1	0	0	0	IL	ISO	ISO	ISO
0	1	0	0	ISO	IL	ISO	ISO
0	0	1	0	ISO	ISO	IL	ISO
0	0	0	1	ISO	ISO	ISO	IL

All other conditions not recommended.

Performance is guaranteed only under the conditions listed in the specifications table and is not guaranteed under the full range(s) described by the Absolute Maximum Specifications. Exceeding any of the absolute maximum/minimum specifications may result in permanent damage to the device and will void the warranty.

**CAUTION:** *Although this device is designed to be as robust as possible, ESD (Electrostatic Discharge) can damage this device. This device must be protected at all times from ESD. Static charges may easily produce potentials of several kilovolts on the human body or equipment, which can discharge without detection. Industry-standard ESD precautions must be employed at all times.*

### Typical Performance Data

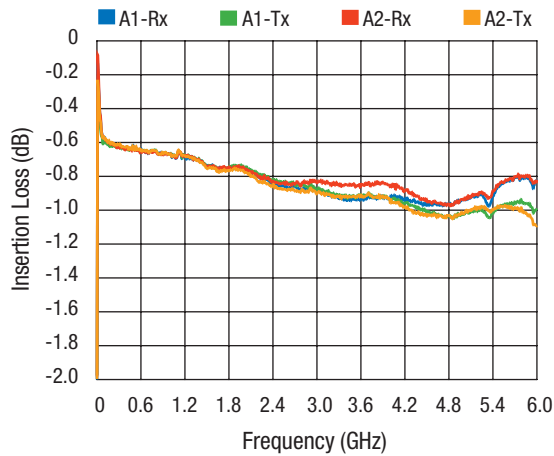

Insertion Loss vs. Frequency

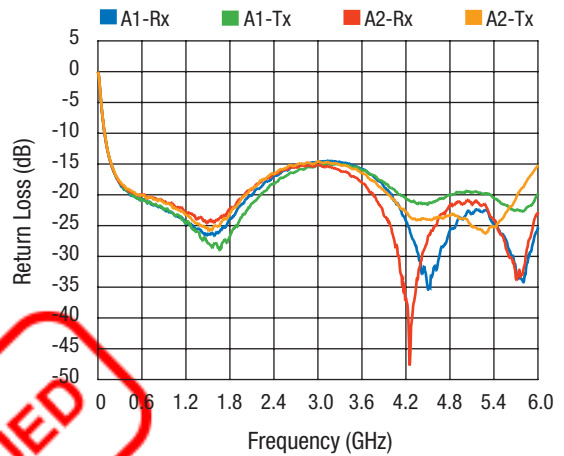

Return Loss vs. Frequency

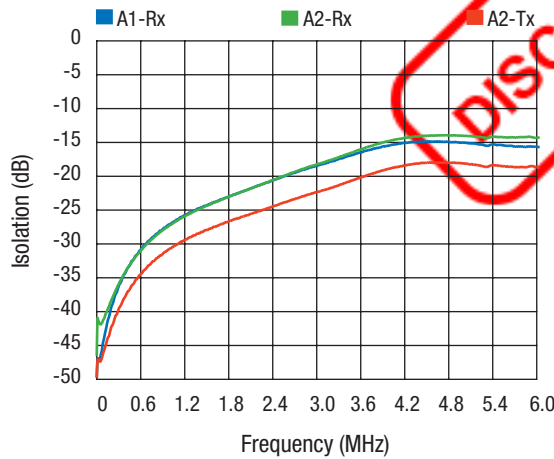

Isolation vs. Frequency

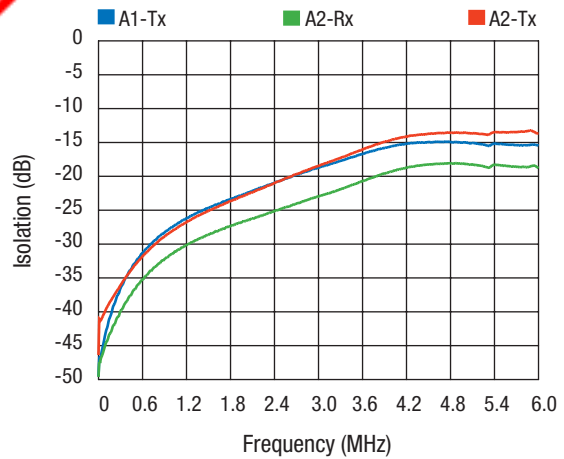

Isolation vs. Frequency

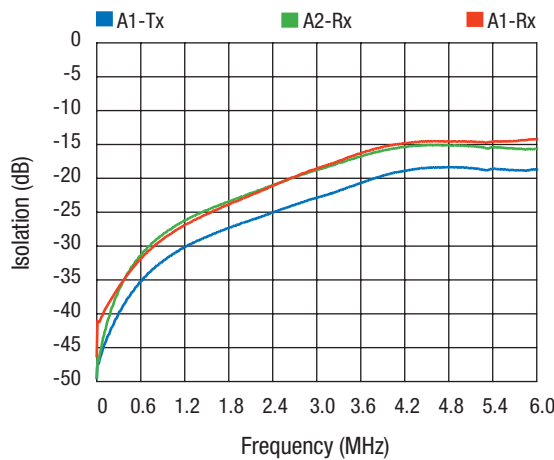

Isolation vs. Frequency

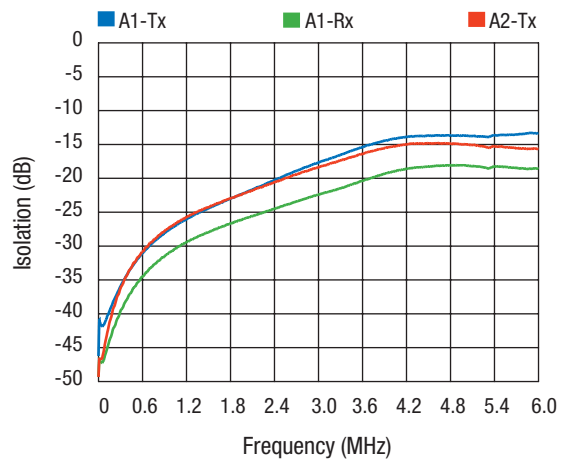

Isolation vs. Frequency

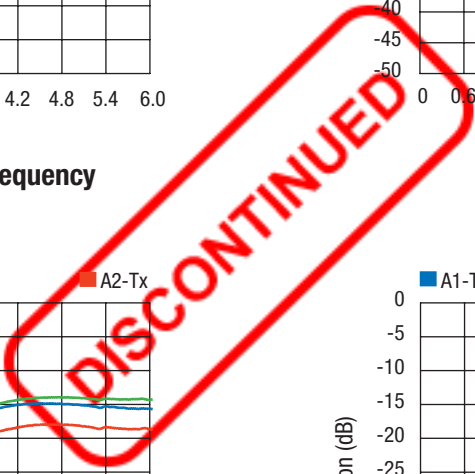

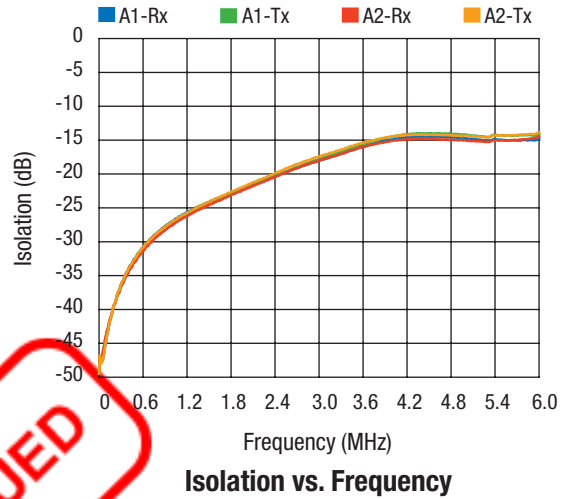
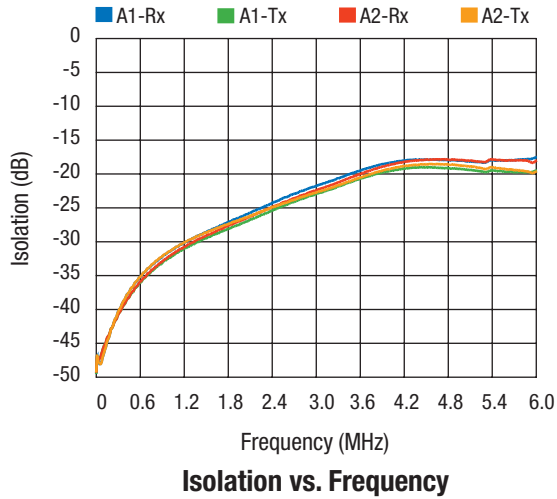

DISCONTINUED

**Suggested Land Pattern**

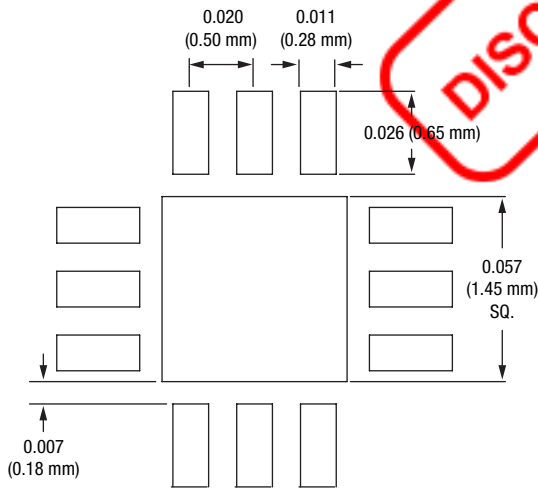

Dimensions in inches (mm).

**QFN-12**

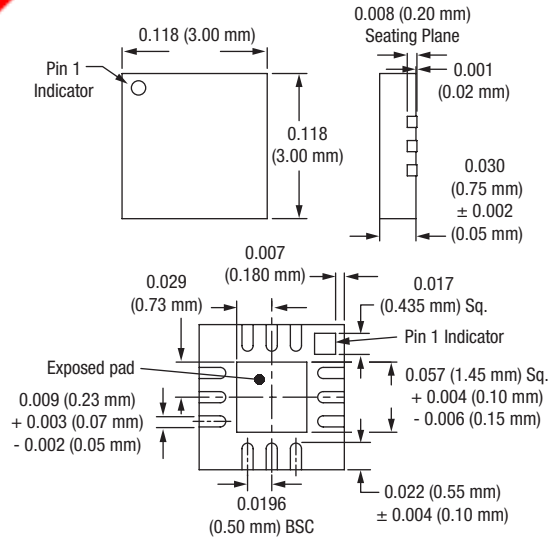

**Recommended Solder Reflow Profiles**

Refer to the [“Solder Reflow Information”](#) Application Note, document number 200164.

**Tape and Reel Information**

Refer to the [“Discrete Devices and IC Switch/Attenuators Tape and Reel Package Orientation”](#) Application Note, document number 200083.



Copyright © 2008, 2009, Skyworks Solutions, Inc. All Rights Reserved.

Information in this document is provided in connection with Skyworks Solutions, Inc. ("Skyworks") products or services. These materials, including the information contained herein, are provided by Skyworks as a service to its customers and may be used for informational purposes only by the customer. Skyworks assumes no responsibility for errors or omissions in these materials or the information contained herein. Skyworks may change its documentation, products, services, specifications or product descriptions at any time, without notice. Skyworks makes no commitment to update the materials or information and shall have no responsibility whatsoever for conflicts, incompatibilities, or other difficulties arising from any future changes.

No license, whether express, implied, by estoppel or otherwise, is granted to any intellectual property rights by this document. Skyworks assumes no liability for any materials, products or information provided hereunder, including the sale, distribution, reproduction or use of Skyworks products, information or materials, except as may be provided in Skyworks Terms and Conditions of Sale.

THE MATERIALS, PRODUCTS AND INFORMATION ARE PROVIDED "AS IS" WITHOUT WARRANTY OF ANY KIND, WHETHER EXPRESS, IMPLIED, STATUTORY, OR OTHERWISE, INCLUDING FITNESS FOR A PARTICULAR PURPOSE OR USE, MERCHANTABILITY, PERFORMANCE, QUALITY OR NON-INFRINGEMENT OF ANY INTELLECTUAL PROPERTY RIGHT; ALL SUCH WARRANTIES ARE HEREBY EXPRESSLY DISCLAIMED. SKYWORKS DOES NOT WARRANT THE ACCURACY OR COMPLETENESS OF THE INFORMATION, TEXT, GRAPHICS OR OTHER ITEMS CONTAINED WITHIN THESE MATERIALS. SKYWORKS SHALL NOT BE LIABLE FOR ANY DAMAGES, INCLUDING BUT NOT LIMITED TO ANY SPECIAL, INDIRECT, INCIDENTAL, STATUTORY, OR CONSEQUENTIAL DAMAGES, INCLUDING WITHOUT LIMITATION, LOST REVENUES OR LOST PROFITS THAT MAY RESULT FROM THE USE OF THE MATERIALS OR INFORMATION, WHETHER OR NOT THE RECIPIENT OF MATERIALS HAS BEEN ADVISED OF THE POSSIBILITY OF SUCH DAMAGE.

Skyworks products are not intended for use in medical, lifesaving or life-sustaining applications, or other equipment in which the failure of the Skyworks products could lead to personal injury, death, physical or environmental damage. Skyworks customers using or selling Skyworks products for use in such applications do so at their own risk and agree to fully indemnify Skyworks for any damages resulting from such improper use or sale.

Customers are responsible for their products and applications using Skyworks products, which may deviate from published specifications as a result of design defects, errors, or operation of products outside of published parameters or design specifications. Customers should include design and operating safeguards to minimize these and other risks. Skyworks assumes no liability for applications assistance, customer product design, or damage to any equipment resulting from the use of Skyworks products outside of stated published specifications or parameters.

Skyworks, the Skyworks symbol, and "Breakthrough Simplicity" are trademarks or registered trademarks of Skyworks Solutions, Inc., in the United States and other countries. Third-party brands and names are for identification purposes only, and are the property of their respective owners. Additional information, including relevant terms and conditions, posted at [www.skyworksinc.com](http://www.skyworksinc.com), are incorporated by reference.