



DATA SHEET

SKY73085-11: 390 – 500 MHz High Gain and Linearity Diversity Downconversion Mixer for 2G/3G Base Station Transceiver Applications

Applications

- 2G/3G base station transceivers:
 - GSM/EDGE, CDMA, UMTS/WCDMA
- Land mobile radio
- ISM band transceivers
- High performance radio links
- RF identification

Features

- Operating frequency range: 390 to 500 MHz
- IF frequency range: 50 to 250 MHz
- Conversion gain: 9.3 dB
- Input IP3: 24.9 dBm
- Output IP3: 34.2 dBm
- Noise figure: 9.3 dB
- Integrated LO drivers
- Integrated low loss RF baluns
- High linearity IF amplifiers
- On-chip SPDT LO switch (greater than 60 dB LO-to-LO isolation)
- Small, MCM (36-pin, 6 x 6 mm) Pb-free package (MSL3, 260 °C per JEDEC J-STD-020)



Skyworks Green™ products are compliant with all applicable legislation and are halogen-free. For additional information, refer to Skyworks Definition of Green™, document number SQ04-0074.

Description

The SKY73085-11 is a fully integrated diversity mixer that includes Local Oscillator (LO) drivers, an LO switch, high linearity mixers, and large dynamic range Intermediate Frequency (IF) amplifiers. Low loss RF baluns have also been included to reduce design complications and lower system cost.

The SKY73085-11 features an input IP3 of 24.9 dBm and a Noise Figure (NF) of 9.3 dB, making the device an ideal solution for high dynamic range systems such as 2G/3G base station receivers. The LO switch provides more than 60 dB of isolation between LO inputs and supports the switching time required for GSM/EDGE base stations.

The SKY73085-11 is manufactured using a robust silicon BiCMOS process and has been designed for optimum long-term reliability. The SKY73085-11 diversity downconversion mixer is provided in a compact, 36-pin Multi-Chip Module (MCM). A functional block diagram is shown in Figure 1. The pin configuration and package are shown in Figure 2. Signal pin assignments and functional pin descriptions are provided in Table 1.

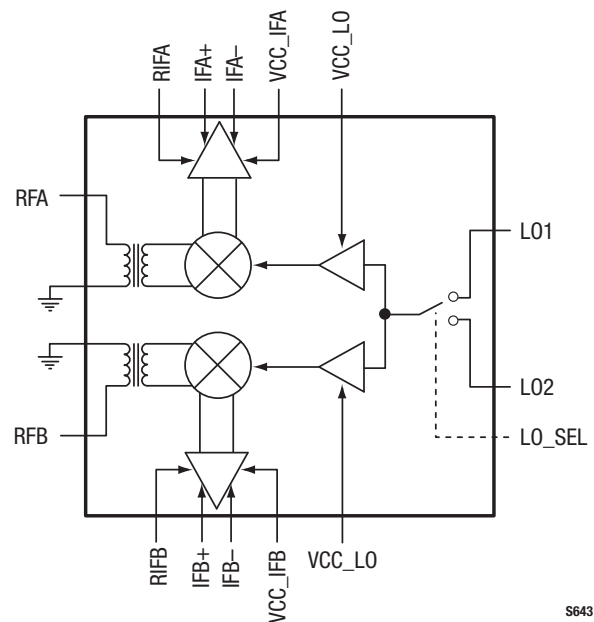

Figure 1. SKY73085-11 Block Diagram

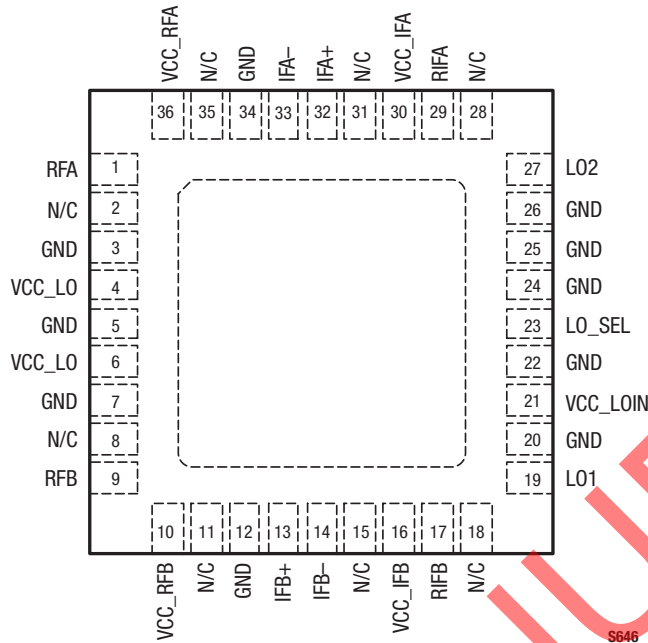

Figure 2. SKY73085-11 Pinout – 36-Pin MCM (Top View)

Table 1. SKY73085-11 Signal Descriptions

Pin #	Name	Description	Pin #	Name	Description
1	RFA	RF channel A input	19	LO1	Local oscillator #1 input
2	NC	No connect	20	GND	Ground
3	GND	Ground	21	VCC_LOIN	DC supply, +5 V
4	VCC_LO	DC supply, +5 V	22	GND	Ground
5	GND	Ground	23	LO_SEL	Local oscillator switch select
6	VCC_LO	DC supply, +5 V	24	GND	Ground
7	GND	Ground	25	GND	Ground
8	NC	No connect	26	GND	Ground
9	RFB	RF channel B input	27	LO2	Local oscillator #2 input
10	VCC_RFB	DC supply, +5 V	28	NC	No connect
11	NC	No connect	29	RIFA	IF channel A bias control
12	GND	Ground	30	VCC_IFA	DC supply, +5 V
13	IFB+	IF channel B positive output	31	NC	No connect
14	IFB-	IF channel B negative output	32	IFA+	IF channel A positive output
15	NC	No connect	33	IFA-	IF channel A negative output
16	VCC_IFB	DC supply, +5 V	34	GND	Ground
17	RIFB	IF channel B bias control	35	NC	No connect
18	NC	No connect	36	VCC_RFA	DC supply, +5 V

Functional Description

The SKY73085-11 is a high gain diversity mixer, optimized for base station receiver applications. The device consists of two diversity channels, each consisting of a low loss RF balun, high linearity passive mixer, and a low noise IF amplifier.

LO amplifiers are also included that allow the SKY73085-11 to connect directly to the output of a Voltage Controlled Oscillator (VCO). This eliminates the extra gain stages needed by most discrete passive mixers. A Single Pole, Double Throw (SPDT) switch has been included to select between two different LO inputs for frequency hopping applications (i.e., GSM).

RF Baluns and Passive Mixer

The RF baluns provide a single ended input, which can easily be matched to 50 Ω using a simple matching circuit. The RF baluns offer very low loss and excellent amplitude and phase balance.

The high linearity mixer is a passive, double balanced mixer that provides a very low insertion loss, and excellent 3rd Order Input Insertion Point (IIP3) and linearity performance.

Additionally, the balanced nature of the mixer provides for excellent port-to-port isolation.

LO Buffers and SPDT LO Switch

The LO buffers allow the input power of the SKY73085-11 to be programmed in the range of -6 to +6 dBm. The LO section has been optimized for high-side LO injection. However, the LO can be driven over a wide frequency range with only slight degradation in performance.

A high isolation SPDT switch allows the SKY73085-11 to be used for frequency hopping applications. This switch provides greater than 60 dB of LO1 to LO2 isolation:

LO_SEL Logic:	LO Path Enabled:
High	Pin 19 (LO1)
Low (default)	Pin 27 (LO2)

For applications that do not require frequency hopping, LO_SEL is fixed to one state and the appropriate LO input is used. An internal pull-down resistor on pin 23 (LO_SEL) sets the default LO path to LO2.

IF Amplifier

The SKY73085-11 includes high dynamic range IF amplifiers that follow the passive mixers in the signal path. The outputs require a supply voltage connection using inductive chokes. These choke inductors should be high-Q and have the ability to handle 200 mA or greater.

A simple matching network allows the output ports to be matched to a balanced 200 Ω impedance. The IF amplifiers are optimized for IF frequencies between 40 and 250 MHz. The IF amplifiers can be operated outside of this range, but with a slight degradation in performance.

Electrical and Mechanical Specifications

The absolute maximum ratings of the SKY73085-11 are provided in Table 2. The recommended operating conditions are specified in Table 3 and electrical specifications are provided in Table 4.

Typical performance characteristics of the SKY73085-11 are illustrated in Figures 3 through 28.

Table 2. SKY73085-11 Absolute Maximum Ratings

Parameter	Symbol	Minimum	Typical	Maximum	Units
Supply voltage, +5 V (VCC1 – VCC7)	VCC	4.5	5.0	5.5	V
Supply current	I _{CC}		350	420	mA
RF input power	P _{RF}			20	dBm
LO input power	P _{LO}		0	20	dBm
Operating case temperature	T _C	–40		+85	°C
Junction temperature	T _J			+150	°C
Storage case temperature	T _{STG}	–40		+150	°C

Note: Exposure to maximum rating conditions for extended periods may reduce device reliability. There is no damage to device with only one parameter set at the limit and all other parameters set at or below their nominal value.

Nominal thermal resistance (junction to center ground pad) is 5.1 °C/W.

CAUTION: Although this device is designed to be as robust as possible, Electrostatic Discharge (ESD) can damage this device. This device must be protected at all times from ESD. Static charges may easily produce potentials of several kilovolts on the human body or equipment, which can discharge without detection. Industry-standard ESD precautions should be used at all times.

Table 3. SKY73085-11 Recommended Operating Conditions

Parameter	Symbol	Minimum	Typical	Maximum	Units
Supply voltage, +5 V (VCC1 – VCC7)	VCC	4.75	5.00	5.25	V
Supply current	I _{CC}		350		mA
LO input power	P _{LO}	–6	0	+6	dBm
LO select logic: high	LO_SELH	2.2			V
low	LO_SELN			0.8	V
Operating case temperature	T _C	–40		+85	°C

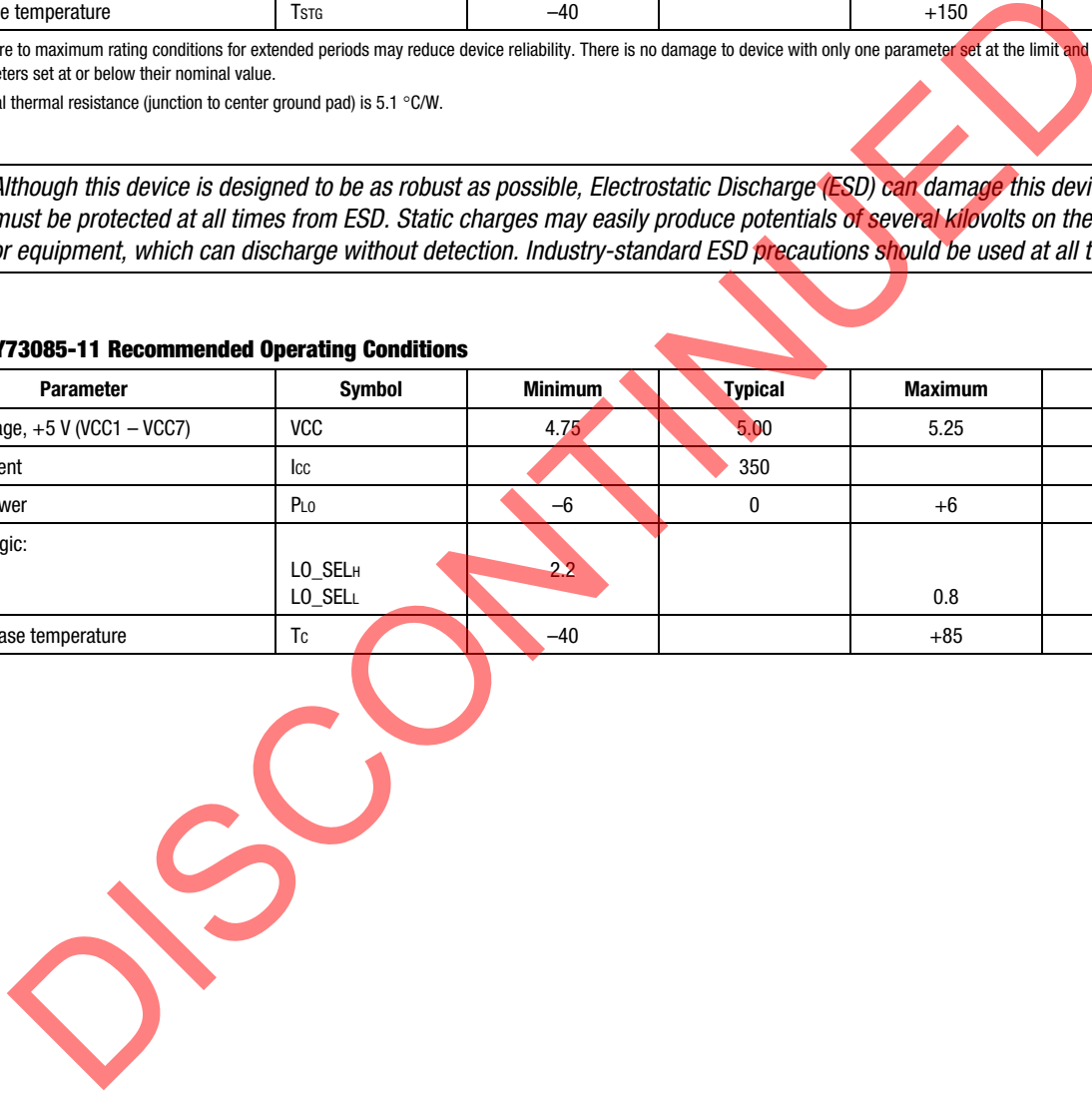

Table 4. SKY73085-11 Electrical Specifications (Note 1)**(Voltage Supply = +5 V, T_c = +25 °C, L_O = 0 dBm, RF Frequency = 450 MHz, IF Frequency = 90 MHz, L_O Frequency = 540 MHz, Unless Otherwise Noted)**

Parameter	Symbol	Test Condition	Min	Typical	Max	Units
RF frequency range	F _{RF}		390	450	500	MHz
LO frequency range (Note 2)	F _{LO}		450	540	650	MHz
IF frequency range	F _{IF}		40	90	250	MHz
LO switching time					1	μs
Conversion gain	G	F _{RF} = 435 to 487 MHz, VCC = 4.75 to 5.25 V, P _{LO} = -3 to +3 dBm	8.3	9.3		dB
Gain variation over temperature		F _{RF} = 450 MHz, T _c = -40 to +85 °C		±0.7		dB
Noise Figure	NF	F _{RF} = 450 MHz		9.3	11.0	dB
Noise Figure variation over temperature		F _{RF} = 450 MHz, T _c = -40 to +85 °C		±0.6		dB
Noise Figure with a blocker signal	NF _{BLK}	Blocking signal input power = +8 dBm		18	25	dB
Third order input intercept point	IIP3	F _{RF} = 450 and 450.8 MHz, P _{RF} = -10 dBm/each tone VCC = 4.75 to 5.25 V, P _{LO} = -3 to +3 dBm	23.5	24.9		dBm
Input IP3 variation over temperature	IIP3	F _{RF} = 450 and 450.8 MHz, T _c = -40 to +85 °C		±1.2		dB
Third order output intercept point	OIP3	F _{RF} = 450 and 450.8 MHz, P _{RF} = -10 dBm/each tone VCC = 4.75 to 5.25 V, P _{LO} = -3 to +3 dBm		34.2		dBm
2RF – 2L _O	2x2	P _{RF} = -10 dBm		-74	-63	dBc
5RF – 4L _O	5x4	P _{RF} = +2 dBm		-100	-93	dBc
Input 1 dB compression point	IP1dB	F _{RF} = 435 to 487 MHz, VCC = 4.75 to 5.25 V, P _{LO} = -3 to +3 dBm	9.5	12.9		dBm
Output 1 dB compression point	OP1dB	F _{RF} = 435 to 487 MHz, VCC = 4.75 to 5.25 V, P _{LO} = -3 to +3 dBm		21.2		dBm
L _{O1} to L _{O2} isolation		F _{rf} = 450 MHz, F _{lo} = 540 MHz	40	62		dB
Channel-to-channel isolation		F _{rf} = 450 MHz, F _{lo} = 540 MHz	30	46		dB
RF to IF isolation		F _{RF} = 450 MHz	30	63		dB
LO leakage:		F _{LO} = 540 MHz				
1xL _O to RF port				-30	-25	dBm
2xL _O to RF port				-29	-25	dBm
3xL _O to RF port				-44	-28	dBm
4xL _O to RF port				-40	-28	dBm
1xL _O to IF port				-40	-23	dBm

Note 1: Performance is guaranteed only under the conditions listed in this Table.**Note 2:** The SKY73085-11 has been optimized for high-side L_O injection. However, the L_O can be used outside of the specified frequency range with degraded performance.

Typical Performance Characteristics

(Voltage Supply = +5 V, $T_c = +25\text{ }^\circ\text{C}$, LO = 0 dBm, RF Frequency = 450 MHz, IF Frequency = 90 MHz, LO Frequency = 540 MHz, Unless Otherwise Noted)

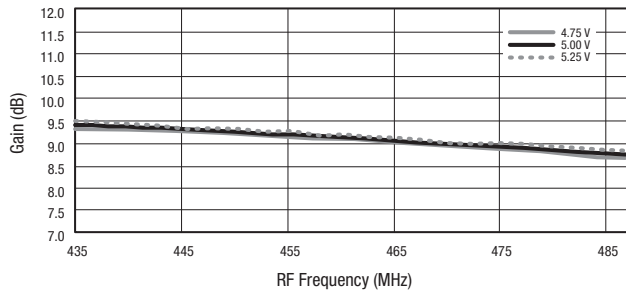

Figure 3. Mixer A Gain vs Frequency and Supply Voltage

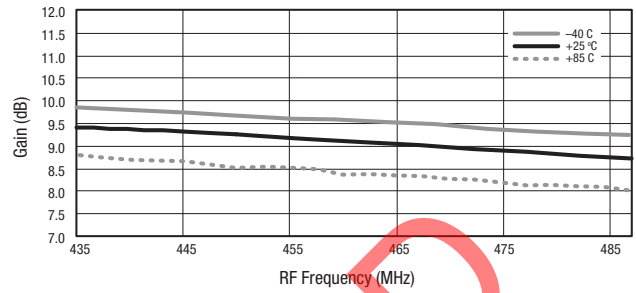

Figure 4. Mixer A Gain vs Frequency and Temperature

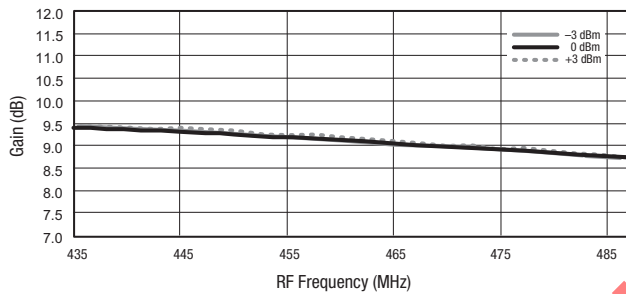

Figure 5. Mixer A Gain vs Frequency and LO Power

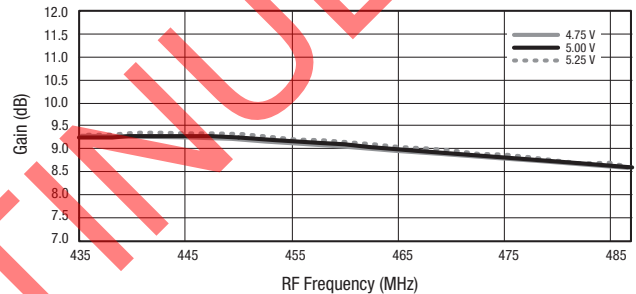

Figure 6. Mixer B Gain vs Frequency and Supply Voltage

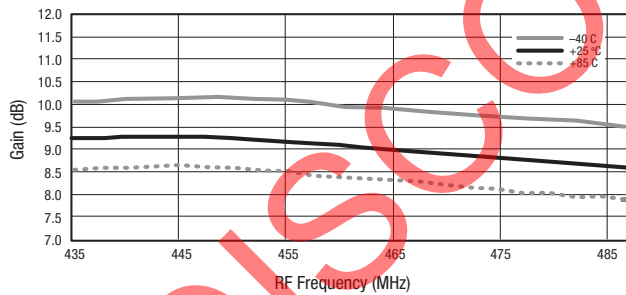

Figure 7. Mixer B Gain vs Frequency and Temperature

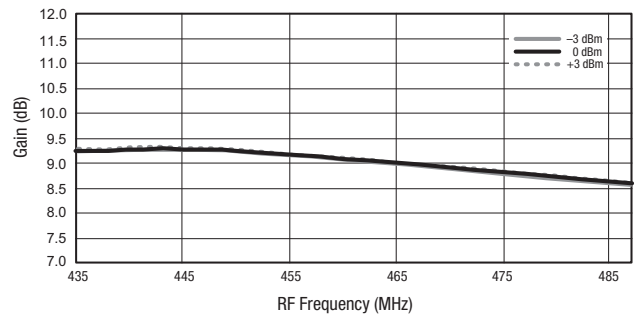

Figure 8. Mixer B Gain vs Frequency and LO Power

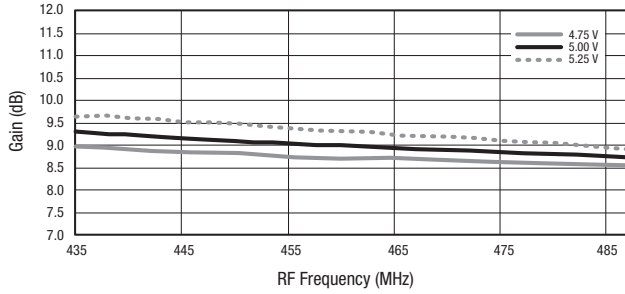

Figure 9. Mixer A Noise Figure vs Frequency and Supply Voltage

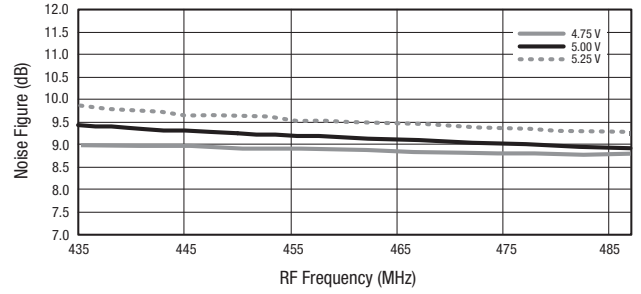

Figure 10. Mixer B Noise Figure vs Frequency and Supply Voltage

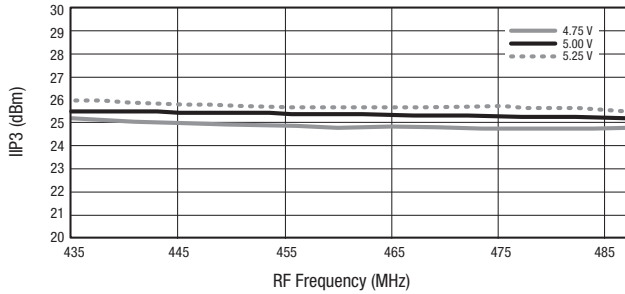

Figure 11. Mixer A IIP3 vs Frequency and Supply Voltage

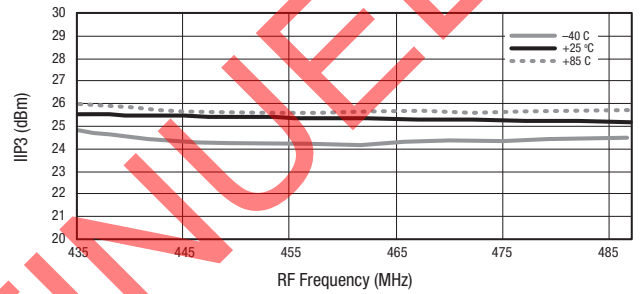

Figure 12. Mixer A IIP3 vs Frequency and Temperature

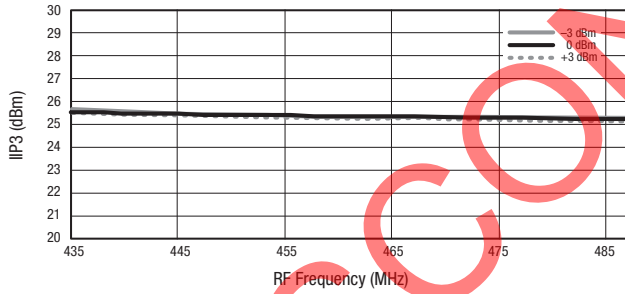

Figure 13. Mixer A IIP3 vs Frequency and LO Power

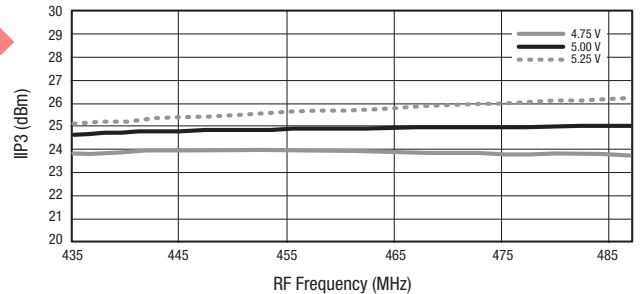

Figure 14. Mixer B IIP3 vs Frequency and Supply Voltage

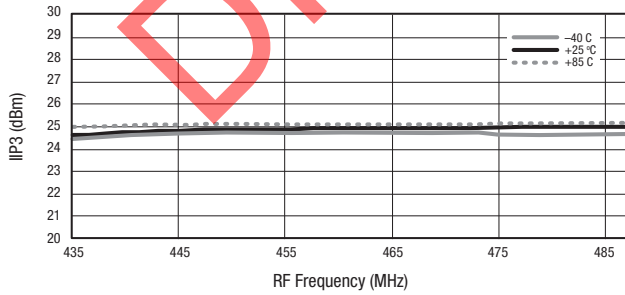

Figure 15. Mixer B IIP3 vs Frequency and Temperature

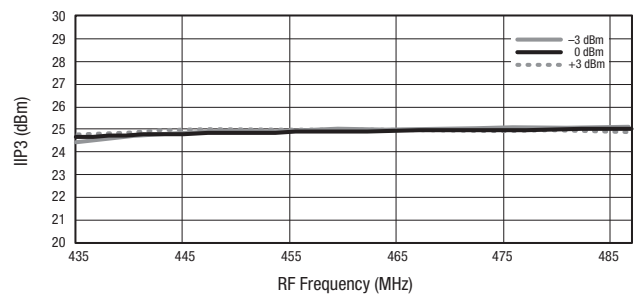

Figure 16. Mixer B IIP3 vs Frequency and LO Power

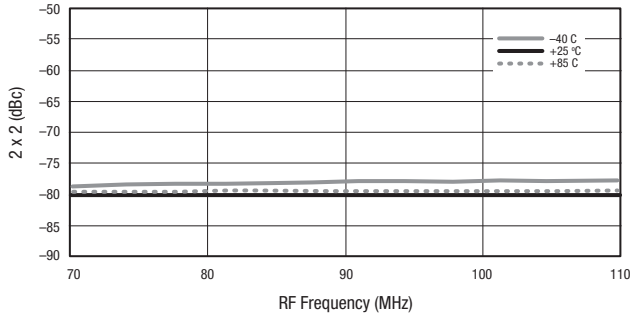

Figure 17. Mixer A 2RF-2LO vs IF Frequency and Temperature

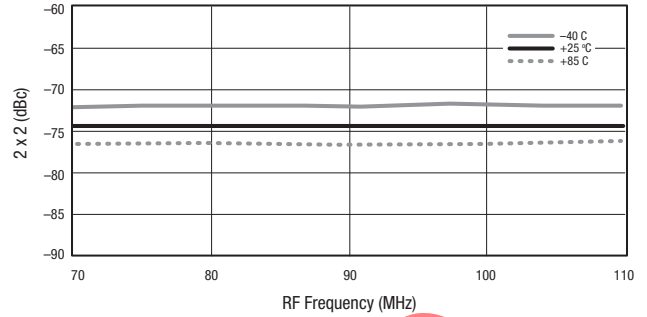

Figure 18. Mixer B 2RF-2LO vs Frequency and Temperature

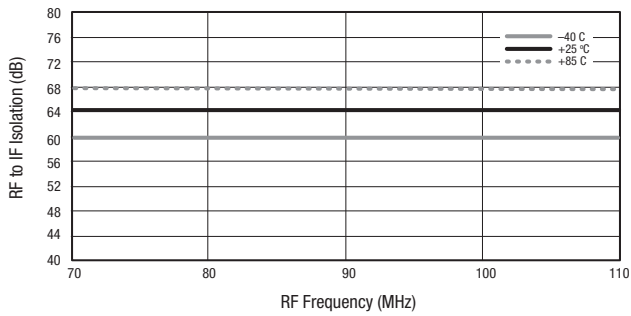

Figure 19. Mixer A RF to IF Isolation vs IF Frequency and Temperature

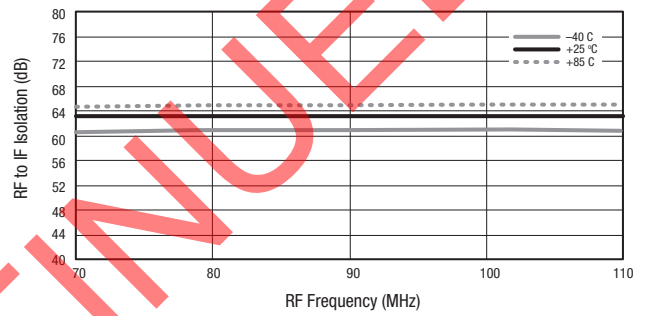

Figure 20. Mixer B RF to IF Isolation vs IF Frequency and Temperature

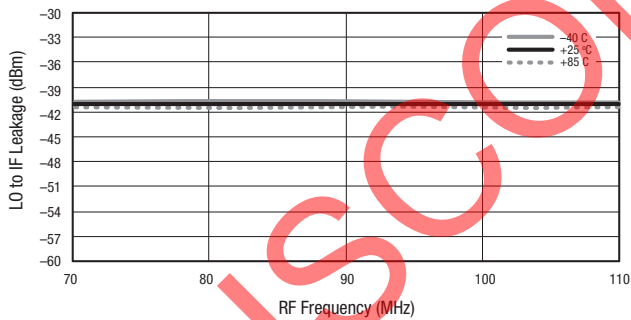

Figure 21. Mixer A LO to IF Leakage vs Frequency and Temperature

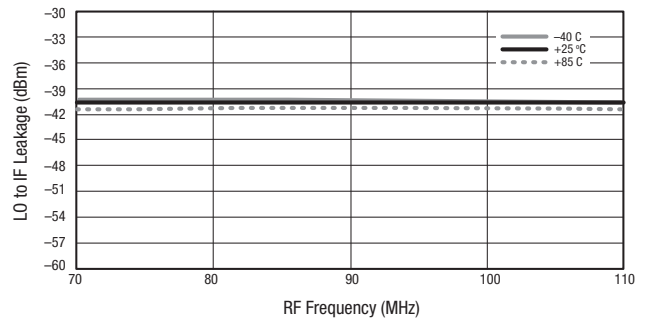

Figure 22. Mixer B LO to IF Leakage vs IF Frequency and Temperature

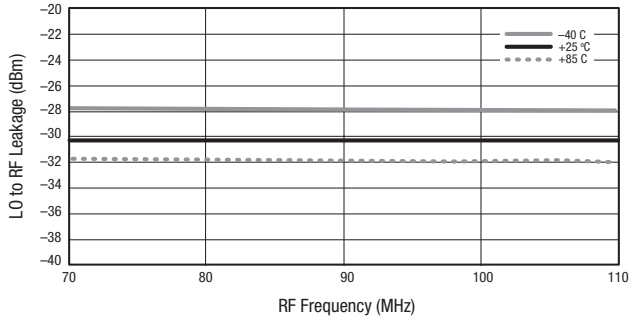

Figure 23. Mixer A to RF Leakage vs Frequency and Temperature

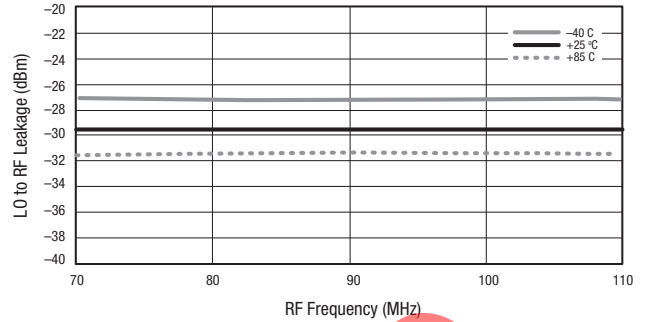

Figure 24. Mixer B LO to RF Leakage vs Frequency and Temperature

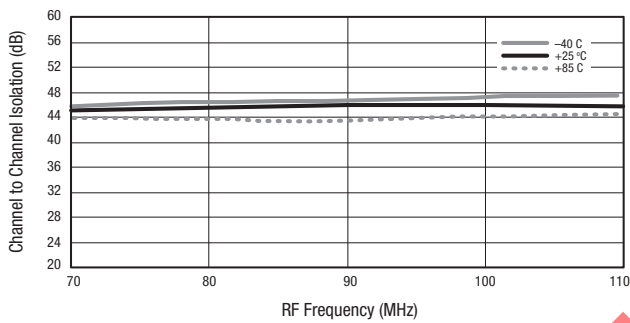

Figure 25. Channel A to Channel B IF Isolation vs Frequency and Supply Voltage

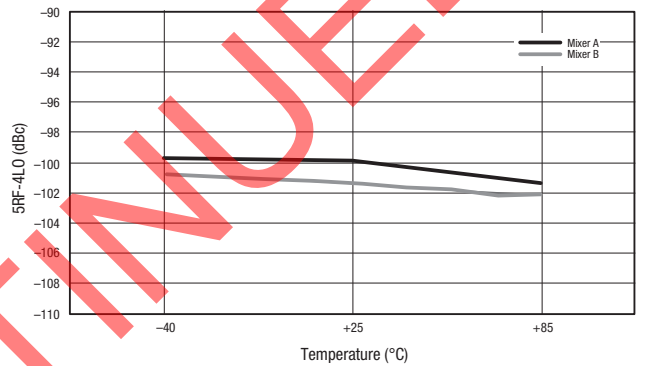

Figure 26. Mixer A and B 5RF-4LO vs Temperature

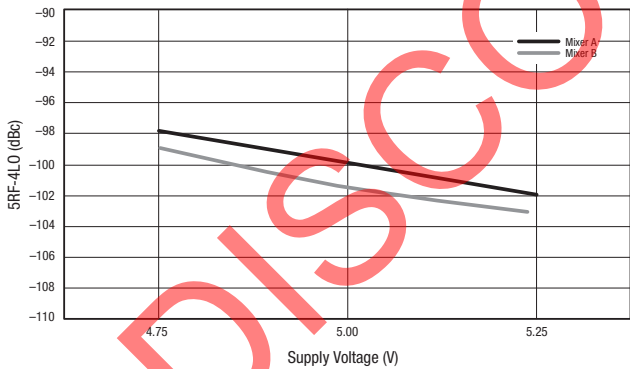

Figure 27. Mixer A and B 5RF-4LO vs Supply Voltage

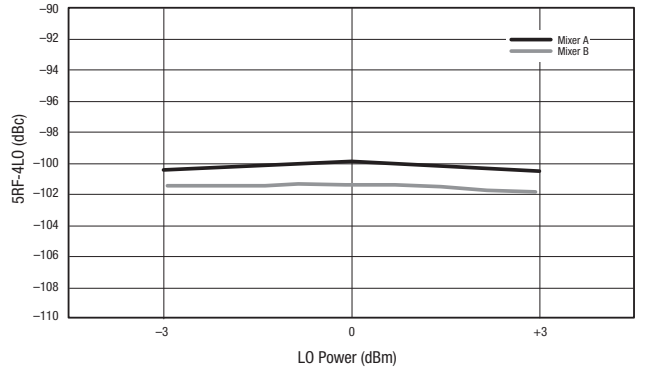

Figure 28. Mixer A and B 5RF-4LO vs LO Power

Evaluation Board Description

The SKY73085-11 Evaluation Board is used to test the performance of the SKY73085-11 downconversion mixer. An assembly drawing for the Evaluation Board is shown in Figure 29 and the layer detail is provided in Figure 30. A schematic diagram of the SKY73085-11 Evaluation Board is shown in Figure 31.

Circuit Design Considerations

The following design considerations are general in nature and must be followed regardless of final use or configuration:

1. Paths to ground should be made as short as possible.
2. The ground pad of the SKY73085-11 has special electrical and thermal grounding requirements. This pad is the main thermal conduit for heat dissipation. Since the circuit board acts as the heat sink, it must shunt as much heat as possible from the device. Therefore, design the connection to the ground pad to dissipate the maximum wattage produced by the circuit board.
3. Skyworks recommends including external bypass capacitors on the VCC voltage inputs of the device.
4. Components L5, L6, L14, and L15 (see Figure 31) are high-Q low loss inductors. These inductors must be able to pass currents in excess of 200 mA DC.
5. Components R1 and R2 (see Figure 31) set the bias current for the IF amplifiers. Skyworks recommends that these resistors have a tolerance of $\pm 1\%$ to optimize performance consistency of the SKY73085-11. These resistors are not required for the Evaluation Board to operate as specified in Tables 3 and 4.

Package Dimensions

The PCB layout footprint for the SKY73085-11 is provided in Figure 32. Figure 33 shows the package dimensions for the 36-pin MCM and Figure 34 provides the tape and reel dimensions.

Package and Handling Information

Since the device package is sensitive to moisture absorption, it is baked and vacuum packed before shipping. Instructions on the shipping container label regarding exposure to moisture after the container seal is broken must be followed. Otherwise, problems related to moisture absorption may occur when the part is subjected to high temperature during solder assembly.

THE SKY73085-11 is rated to Moisture Sensitivity Level 3 (MSL3) at 260 °C. It can be used for lead or lead-free soldering. For additional information, refer to the Skyworks Application Note, *PCB Design & SMT Assembly/Rework Guidelines for MCM-L Packages*, document number 101752.

Care must be taken when attaching this product, whether it is done manually or in a production solder reflow environment. Production quantities of this product are shipped in a standard tape and reel format.

DISCONTINUED

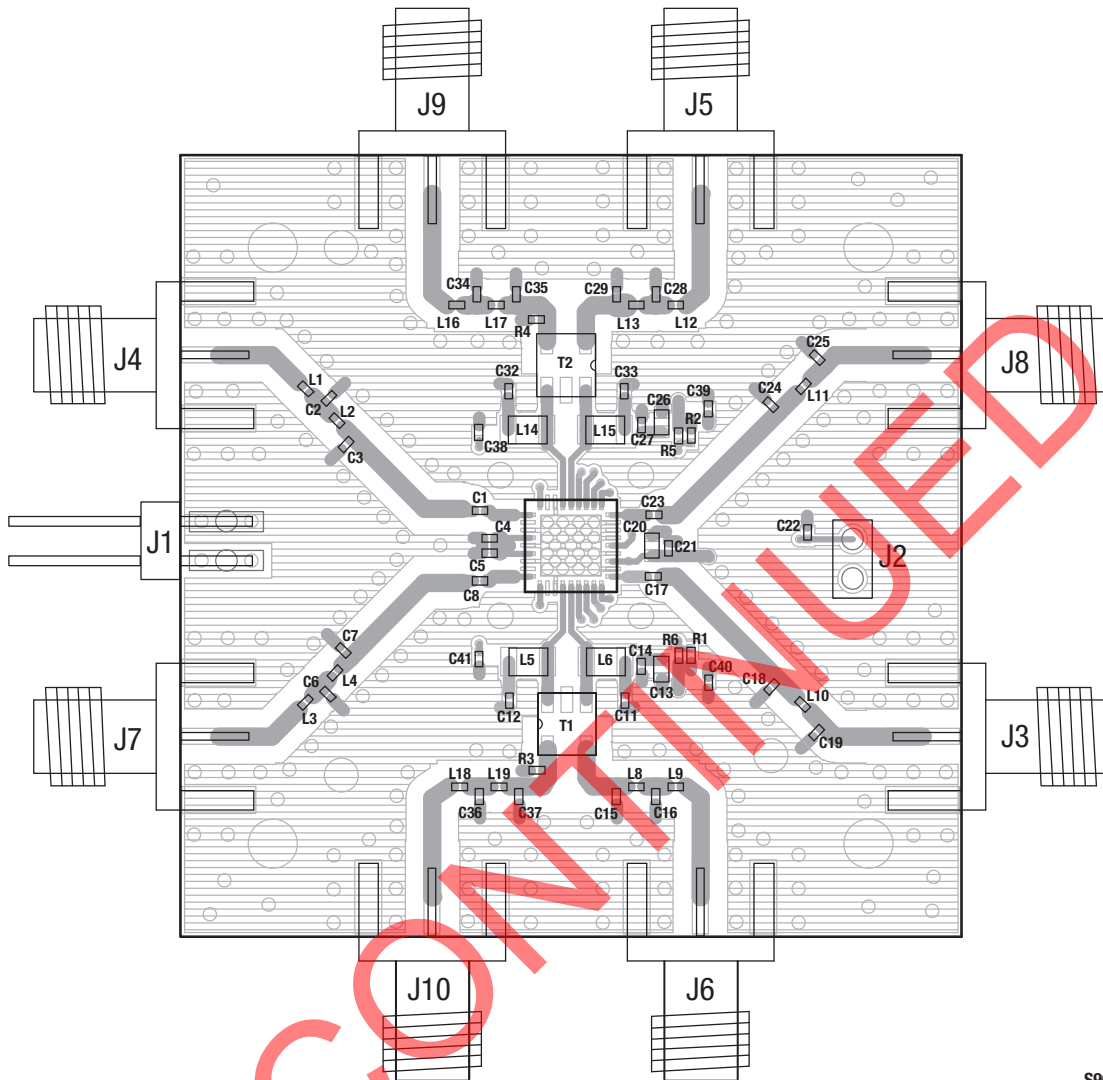

S905

Figure 29. SKY73085-11 Evaluation Board Assembly Diagram

DISCONTINUED

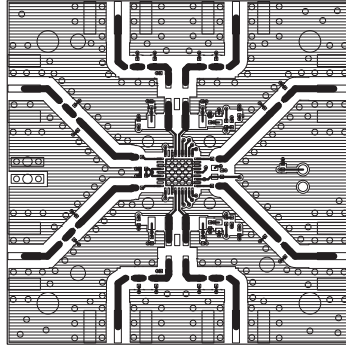

Layer 1: Top -- Metal

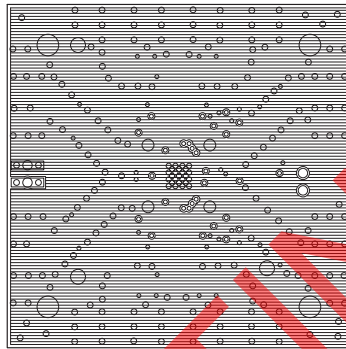

Layer 2: Ground

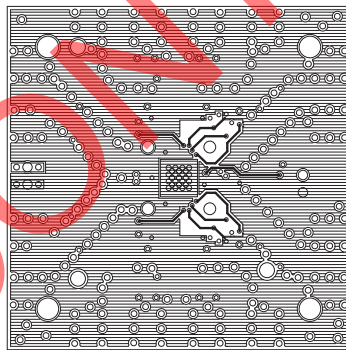

Layer 3: Power Plane

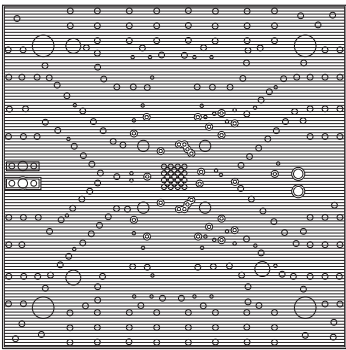

Layer 4: Solid Ground Plane

S904

Figure 30. SKY73085-11 Evaluation Board Layer Detail

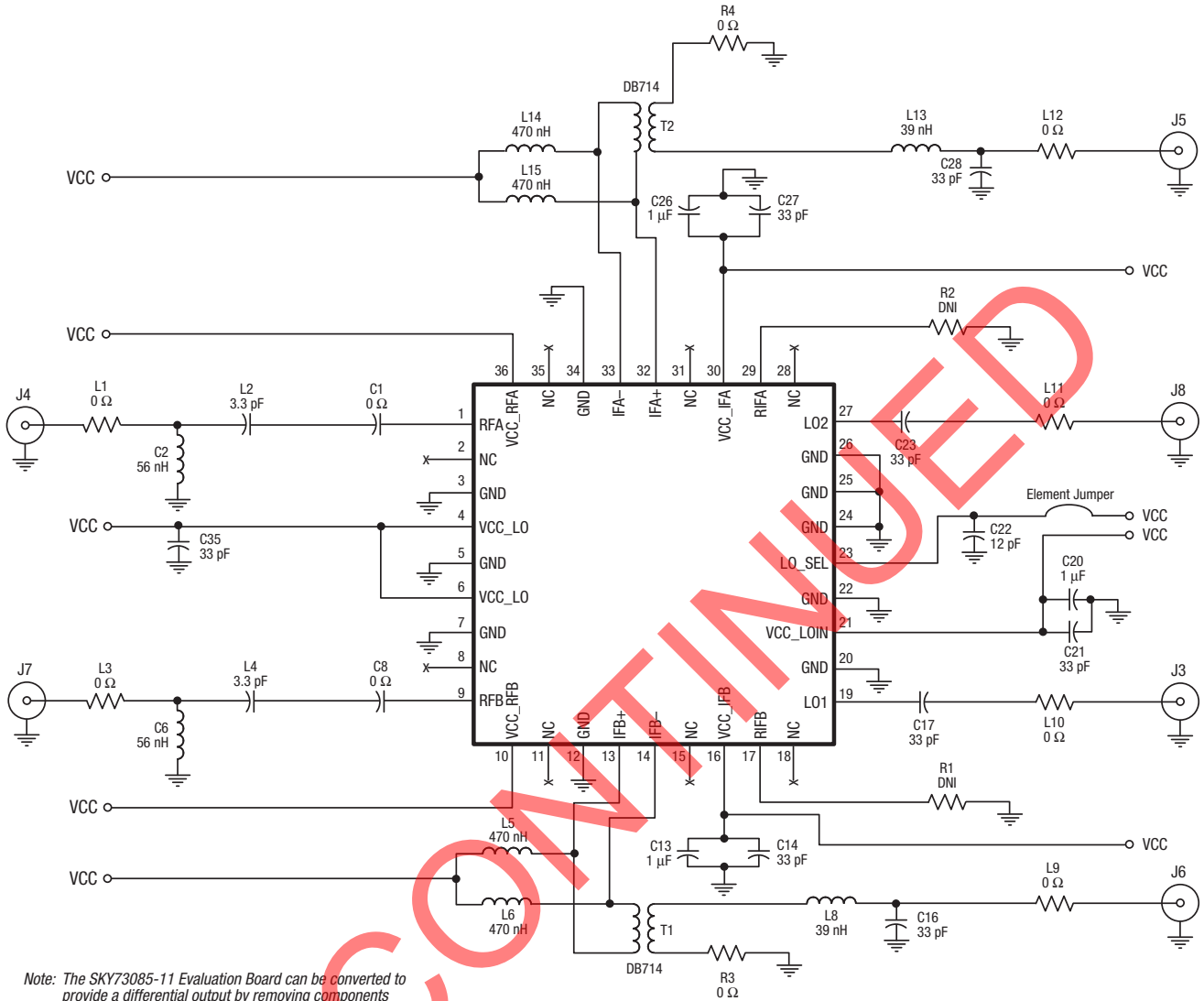

Note: The SKY73085-11 Evaluation Board can be converted to provide a differential output by removing components T1, T2, R3, and R4.

Some component labels may be different than the corresponding component symbol shown here. Component values, however, are accurate as of the date of this Data Sheet.

S1334

Figure 31. SKY73085-11 Evaluation Board Schematic

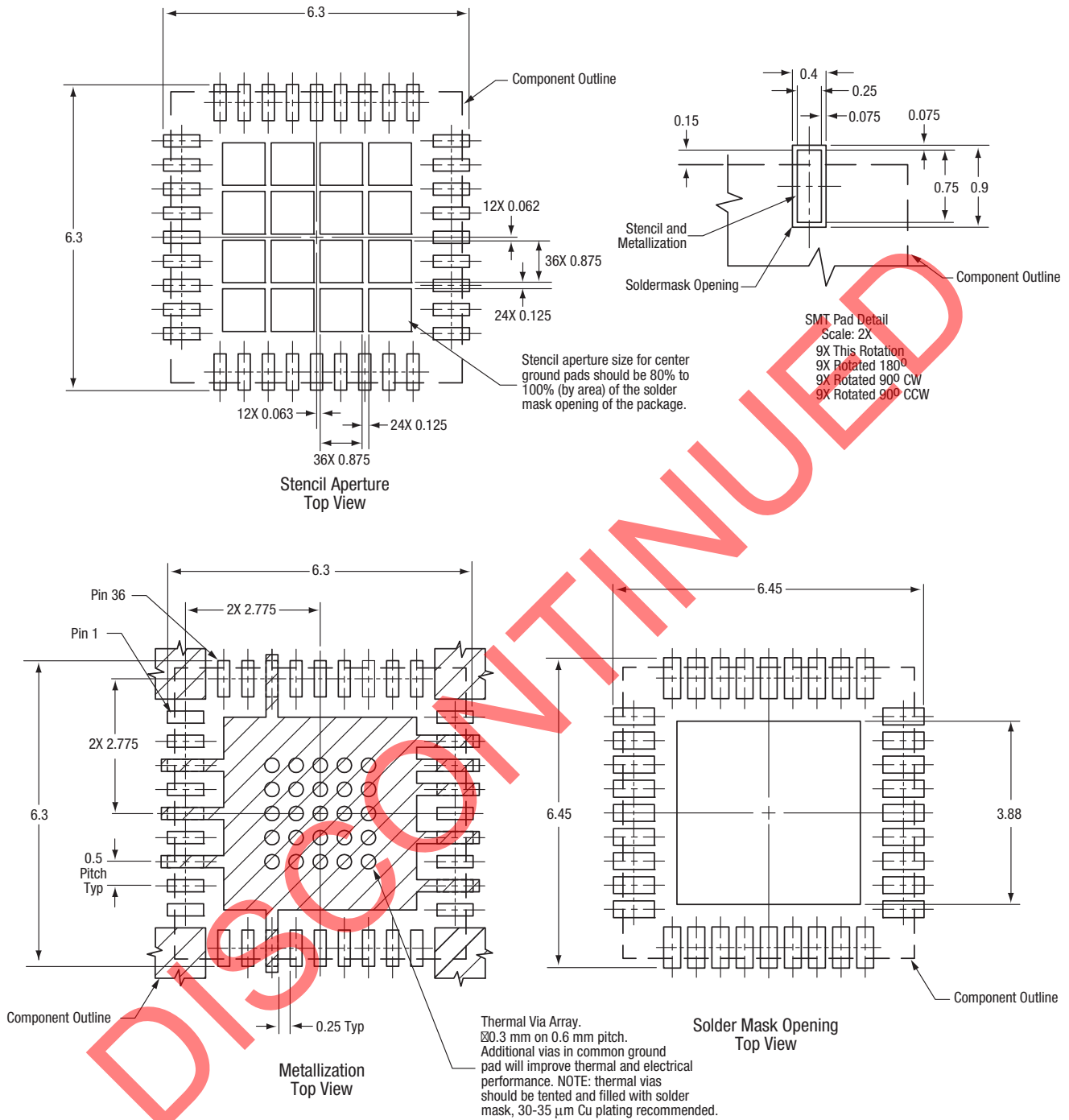

Note: The cross-hatched area represents the merger of the center ground pad +10 individual I/O ground pads. All I/O ground pads should have at least one via connected to internal ground planes for optimum electrical performance.

All measurements are in millimeters

S1125

Figure 32. PCB Layout Footprint for the SKY73085-11 6 x 6 mm MCM

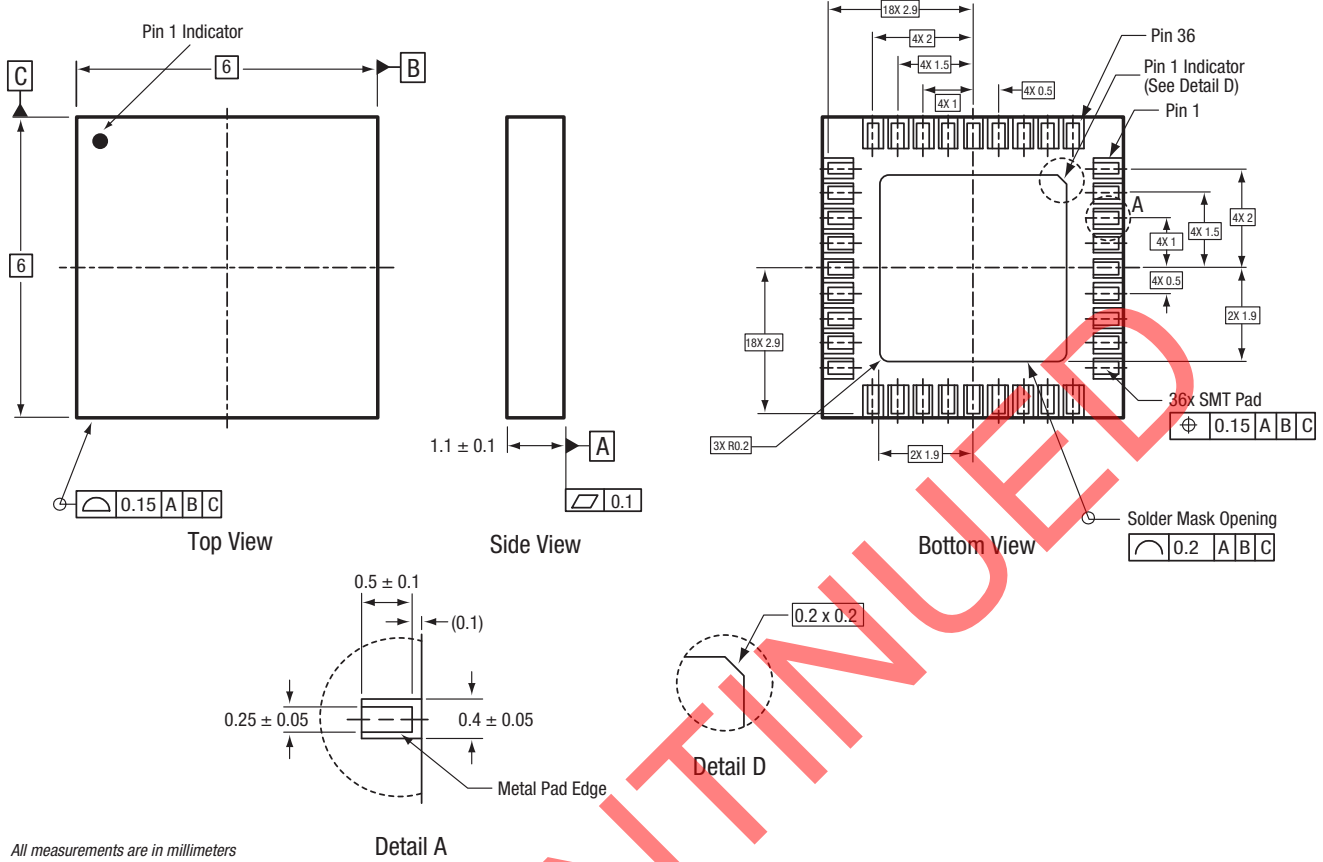

All measurements are in millimeters

Pads are solder mask defined on one edge and metal defined on three edges.

Dimensioning and tolerancing according to ASME Y14.5M-1994

S689_A

Figure 33. SKY73085-11 36-Pin MCM Package Dimensions

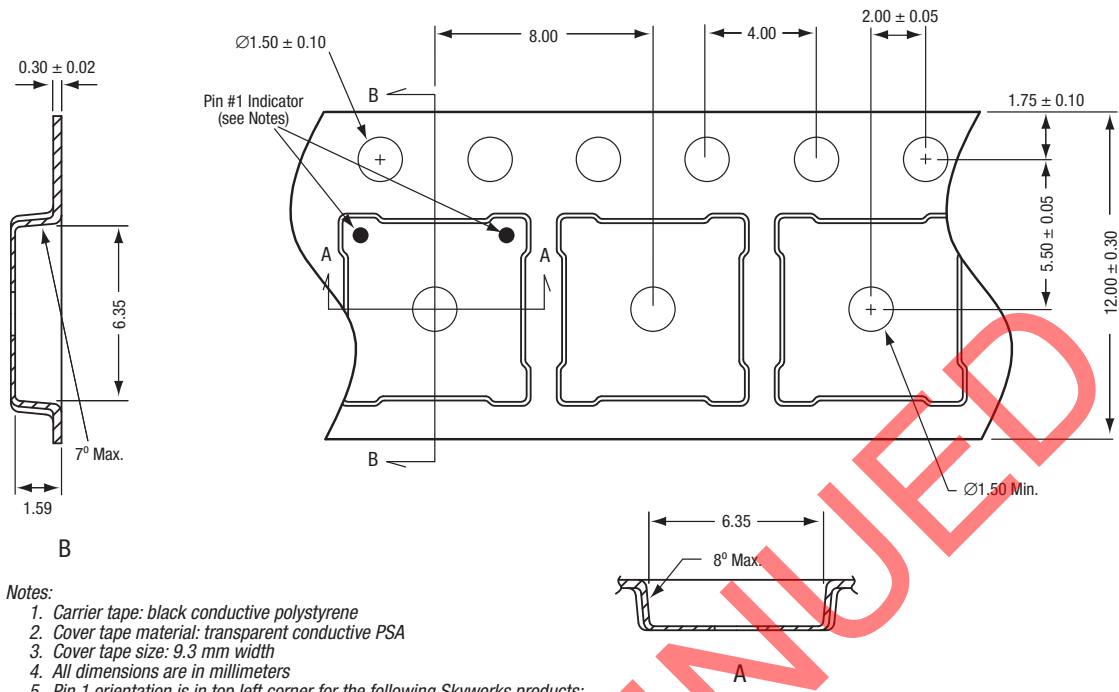

Notes:

1. Carrier tape: black conductive polystyrene
2. Cover tape material: transparent conductive PSA
3. Cover tape size: 9.3 mm width
4. All dimensions are in millimeters
5. Pin 1 orientation is in top left corner for the following Skyworks products:

SKY73022-21, -31
 SKY73023-21, -31

For all other 6 x 6 mm MCM/RFLGA products, pin 1 orientation is in top right corner.

S1183

Figure 34. SKY73085-11 Tape and Reel Dimensions

DISCONTINUED

Ordering Information

Model Name	Manufacturing Part Number	Evaluation Board Part Number
SKY73085-11 390-500 MHz Downconversion Mixer	SKY73085-11	TW17-D650

Copyright © 2008, 2009, 2011, 2019 Skyworks Solutions, Inc. All Rights Reserved.

Information in this document is provided in connection with Skyworks Solutions, Inc. ("Skyworks") products or services. These materials, including the information contained herein, are provided by Skyworks as a service to its customers and may be used for informational purposes only by the customer. Skyworks assumes no responsibility for errors or omissions in these materials or the information contained herein. Skyworks may change its documentation, products, services, specifications or product descriptions at any time, without notice. Skyworks makes no commitment to update the materials or information and shall have no responsibility whatsoever for conflicts, incompatibilities, or other difficulties arising from any future changes.

No license, whether express, implied, by estoppel or otherwise, is granted to any intellectual property rights by this document. Skyworks assumes no liability for any materials, products or information provided hereunder, including the sale, distribution, reproduction or use of Skyworks products, information or materials, except as may be provided in Skyworks Terms and Conditions of Sale.

THE MATERIALS, PRODUCTS AND INFORMATION ARE PROVIDED "AS IS" WITHOUT WARRANTY OF ANY KIND, WHETHER EXPRESS, IMPLIED, STATUTORY, OR OTHERWISE, INCLUDING FITNESS FOR A PARTICULAR PURPOSE OR USE, MERCHANTABILITY, PERFORMANCE, QUALITY OR NON-INFRINGEMENT OF ANY INTELLECTUAL PROPERTY RIGHT; ALL SUCH WARRANTIES ARE HEREBY EXPRESSLY DISCLAIMED. SKYWORKS DOES NOT WARRANT THE ACCURACY OR COMPLETENESS OF THE INFORMATION, TEXT, GRAPHICS OR OTHER ITEMS CONTAINED WITHIN THESE MATERIALS. SKYWORKS SHALL NOT BE LIABLE FOR ANY DAMAGES, INCLUDING BUT NOT LIMITED TO ANY SPECIAL, INDIRECT, INCIDENTAL, STATUTORY, OR CONSEQUENTIAL DAMAGES, INCLUDING WITHOUT LIMITATION, LOST REVENUES OR LOST PROFITS THAT MAY RESULT FROM THE USE OF THE MATERIALS OR INFORMATION, WHETHER OR NOT THE RECIPIENT OF MATERIALS HAS BEEN ADVISED OF THE POSSIBILITY OF SUCH DAMAGE.

Skyworks products are not intended for use in medical, lifesaving or life-sustaining applications, or other equipment in which the failure of the Skyworks products could lead to personal injury, death, physical or environmental damage. Skyworks customers using or selling Skyworks products for use in such applications do so at their own risk and agree to fully indemnify Skyworks for any damages resulting from such improper use or sale.

Customers are responsible for their products and applications using Skyworks products, which may deviate from published specifications as a result of design defects, errors, or operation of products outside of published parameters or design specifications. Customers should include design and operating safeguards to minimize these and other risks. Skyworks assumes no liability for applications assistance, customer product design, or damage to any equipment resulting from the use of Skyworks products outside of stated published specifications or parameters.

Skyworks, the Skyworks symbol, and "Breakthrough Simplicity" are trademarks or registered trademarks of Skyworks Solutions, Inc., in the United States and other countries. Third-party brands and names are for identification purposes only, and are the property of their respective owners. Additional information, including relevant terms and conditions, posted at www.skyworksinc.com, are incorporated by reference.