

High Current, High Efficiency Charge Pump with Auto-Timer

General Description

The AAT3171 is a high output current, high efficiency, low noise, low profile charge pump DC/DC converter. The device is ideal for multi-functional LED photo-flash applications where solution cost, size, and efficiency are critical.

The AAT3171 is capable of driving a regulated output current up to 800mA. Output current levels can be easily programmed in 16 steps through Skyworks' Simple Serial Control™ (S²Cwire™) interface controlled by a single microcontroller GPIO line. This allows smooth transitions and flexible adjustment of brightness in flash or other lighting modes. The maximum output current can also be set with an external R_{SET} resistor.

The tri-mode (1x/1.5x/2x) operation of the internal charge pump offers excellent power efficiency throughout the output current range for both flash and movie modes. Combined with a low external parts count (two 1μF flying capacitors and two small bypass capacitors at VIN and OUT), the AAT3171 is ideally suited for small battery-powered applications.

The AAT3171 has a thermal management system to protect the device in the event of a short-circuit condition at the output pin. Built-in soft-start circuitry prevents excessive inrush current during start-up. The shutdown feature disconnects the load from V_{IN} and reduces quiescent current to less than 1μA.

The AAT3171 is available in a Pb-free, thermally-enhanced 12-pin 3x3mm TDFN package and is specified over the -40°C to +85°C temperature range.

Features

- Up to 800mA Output Current
- Tri-Mode 1X/1.5X/2X in Current Mode
- 16 Current Level Steps Set by S²Cwire
- External R_{SET} to Set Maximum Current
- <1μA of Shutdown
- Small Application Circuit
- No Inductors
- Automatic Soft Start
- 12-Pin TDFN 3x3mm Package
- -40°C to +85°C Temperature Range

Applications

- Camcorders
- Camera Phones
- Digital Still Cameras
- PDAs and Notebook PCs
- Smart Phones

Typical Application

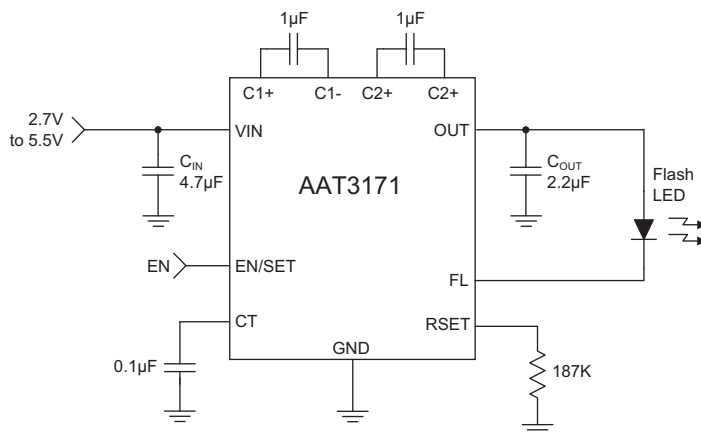

DATA SHEET

AAT3171

High Current, High Efficiency Charge Pump with Auto-Timer

Pin Descriptions

Pin #	Symbol	Function
1	VIN	Input power supply pin. Connect Pin 1 directly to Pin 12 and then to input supply voltage. Connect a 4.7 μ F or larger ceramic capacitor to ground.
2	C1+	Flying capacitor C1 positive terminal. Connect a 1 μ F ceramic capacitor between C1+ and C1-.
3	C1-	Flying capacitor C1 negative terminal.
4	GND	Ground connection.
5	FL	Controlled current sink. Connect the flash LED cathode to this pin.
6	RSET	Connect resistor here to set maximum output current.
7	EN/SET	Charge pump enable / set input control pin. When in the low state, the AAT3171 is powered down and consumes less than 1 μ A. When connected to logic high level, the AAT3171 charge pump is active. This pin should not be left floating.
8	CT	Flash timeout capacitor. Connect a 0.1 μ F capacitor between this pin and GND for a flash timeout of 1 second.
9	C2-	Flying capacitor C2 negative terminal.
10	C2+	Flying capacitor C2 positive terminal. Connect a 1 μ F ceramic capacitor between C2+ and C2-.
11	OUT	Charge pump output. Connect a 2.2 μ F or larger ceramic capacitor to ground. Connect to flash LED anode to drive the LED.
12	VIN	Input power supply pin. Connect Pin 12 directly to Pin 1 and then to input supply voltage.
EP		Exposed paddle (bottom). Connect to GND directly beneath package.

Pin Configuration

TDFN33-12
(Top View)

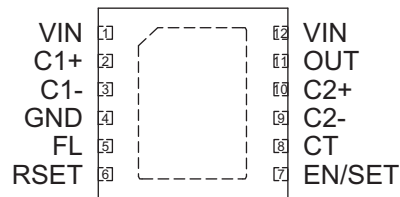

High Current, High Efficiency Charge Pump with Auto-Timer

Absolute Maximum Ratings¹

T_A = 25°C unless otherwise noted.

Symbol	Description	Value	Units
V _{IN}	Input Voltage	-0.3 to 6.0	V
V _{EN}	EN to GND Voltage	-0.3 to 6.0	V
V _{EN(MAX)}	Maximum EN to Input Voltage	V _{IN} + 0.3	V
I _{OUT}	Maximum Output Current	1000	mA
T _J	Operating Temperature Range	-40 to 150	°C
T _S	Storage Temperature Range	-65 to 150	°C
T _{LEAD}	Maximum Soldering Temperature (at leads, 10 sec.)	300	°C

Thermal Information²

Symbol	Description	Value	Units
θ _{JA}	Thermal Resistance	50	°C/W
P _D	Maximum Power Dissipation ³	2	W

1. Stresses above those listed in Absolute Maximum Ratings may cause permanent damage to the device. Functional operation at conditions other than the operating conditions specified is not implied. Only one Absolute Maximum Rating should be applied at any one time.
 2. Mounted on an FR4 board.
 3. Derate 20mW/°C above 40°C ambient temperature.

DATA SHEET

AAT3171

High Current, High Efficiency Charge Pump with Auto-Timer

Electrical Characteristics¹

$C_{IN} = 4.7\mu\text{F}$, $C_{OUT} = 2.2\mu\text{F}$, $C_1 = C_2 = 1.0\mu\text{F}$; $T_A = -40^\circ\text{C}$ to $+85^\circ\text{C}$, unless otherwise noted. Typical values are $T_A = 25^\circ\text{C}$, $V_{IN} = 3.6\text{V}$.

Symbol	Description	Conditions	Min	Typ	Max	Units
Power Supply						
V_{IN}	Input Voltage Range		2.7		5.5	V
I_{CC}	Operating Current	1X, No Load Current		300		μA
		$3.0 \leq V_{IN} \leq 5.5$, 1.5X Mode, No Load Current		2.0	4.0	mA
		$3.0 \leq V_{IN} \leq 5.5$, 2X Mode, No Load Current		3.0	6.0	
$I_{SHDN(MAX)}$	V_{IN} Pin Shutdown Current	EN = 0			1.0	μA
$I_{OUT(MAX)}$	Maximum Output Current ²	$V_F = 3.6\text{V}$		800		mA
I_{DX}	Output Current Accuracy	Programmed for 600mA; $R_{SET} = 187\text{k}\Omega$	540		660	mA
T_{SS}	Soft-Start Time			200		μs
V_{RSET}	R_{SET} Pin Voltage			0.7		V
EN/SET						
$V_{EN(L)}$	Enable Threshold Low	$V_{IN} = 2.7\text{V}$			0.4	V
$V_{EN(H)}$	Enable Threshold High	$V_{IN} = 5.5\text{V}$	1.4			V
$T_{EN/SET LO}$	EN/SET Low Time		0.3		75	μs
$T_{EN/SET HI}$	Minimum EN/SET High Time			50		ns
$T_{EN/SET HI MAX}$	Maximum EN/SET High Time				75	μs
T_{OFF}	EN/SET Off Timeout				500	μs
T_{LAT}	EN/SET Latch Timeout				500	μs
Input Current	EN/SET Input Leakage		-1		1	μA

- The AAT3171 is guaranteed to meet performance specifications from 0°C to 70°C . Specification over the -40°C to $+85^\circ\text{C}$ operating temperature range is assured by design, characterization, and correlation with statistical process controls.
- Mounted on an FR4 board.

High Current, High Efficiency Charge Pump with Auto-Timer

Typical Characteristics

$V_{IN} = 3.6V$, $C_{IN} = 4.7\mu F$, $C_{OUT} = 2.2\mu F$, $C_1 = C_2 = 1\mu F$, $T_A = 25^\circ C$, unless otherwise noted.

Efficiency vs. Supply Voltage

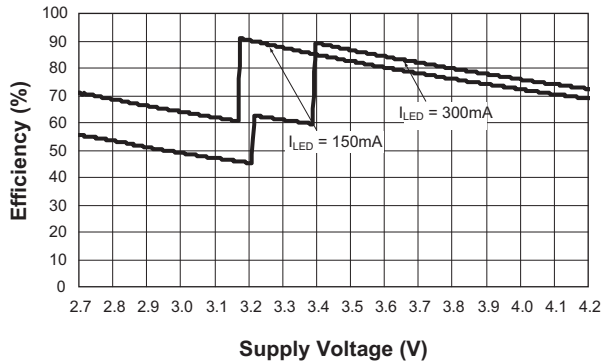

Turn-On to 1X Mode
($V_{IN} = 4.2V$; $I_{LED} = 150mA$)

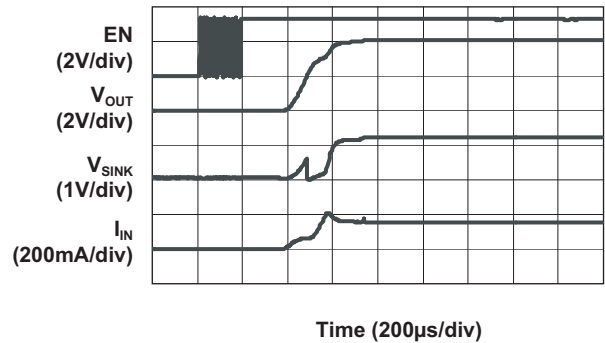

Turn-On to 1.5X Mode
($V_{IN} = 3.2V$; $I_{LED} = 150mA$)

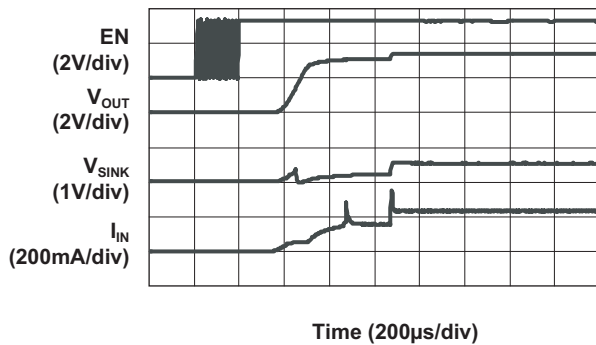

Turn-On to 1X Mode
($V_{IN} = 4.2V$; $I_{LED} = 600mA$)

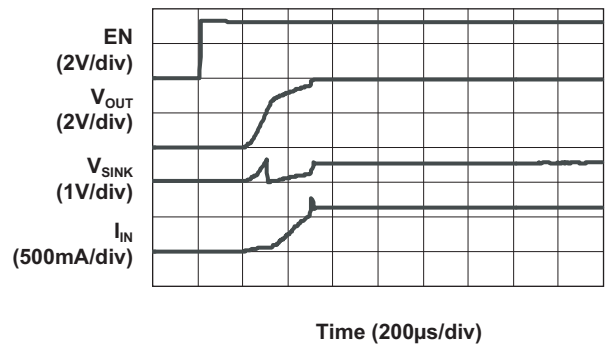

Turn-On to 2X Mode
($V_{IN} = 3.2V$; $I_{LED} = 600mA$)

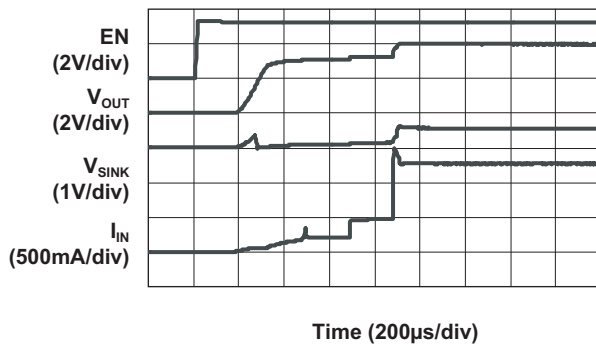

Turn-Off from 1.5X Mode
($V_{IN} = 3.2V$; $I_{LED} = 150mA$)

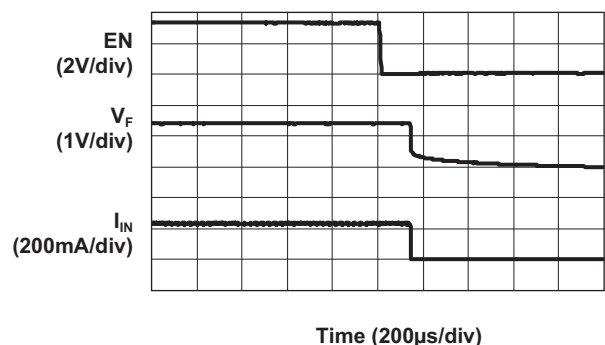

High Current, High Efficiency Charge Pump with Auto-Timer

Typical Characteristics

$V_{IN} = 3.6V$, $C_{IN} = 4.7\mu F$, $C_{OUT} = 2.2\mu F$, $C_1 = C_2 = 1\mu F$, $T_A = 25^\circ C$, unless otherwise noted.

Operating Characteristic
($V_{IN} = 3.3V$; 1.5X Mode; $I_{LED} = 300mA$)

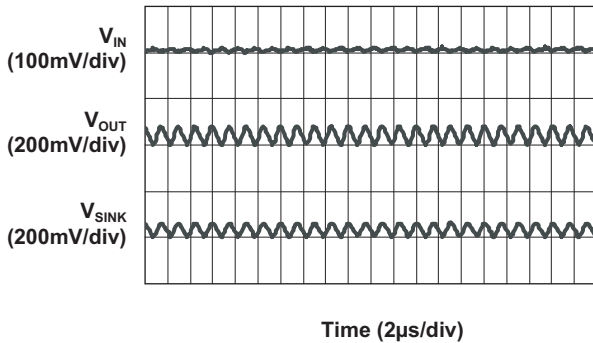

Operating Characteristic
($V_{IN} = 2.9V$; 2X Mode; $I_{LED} = 300mA$)

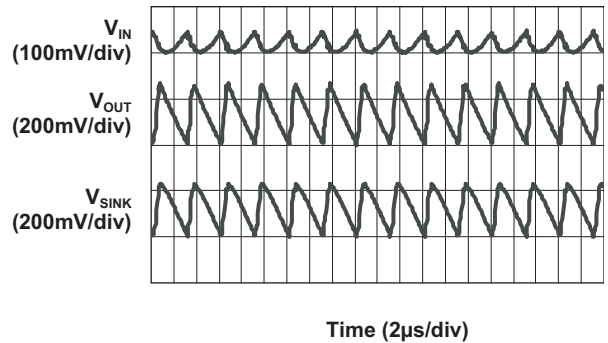

LED Current vs. R_{SET}
(Data = 1)

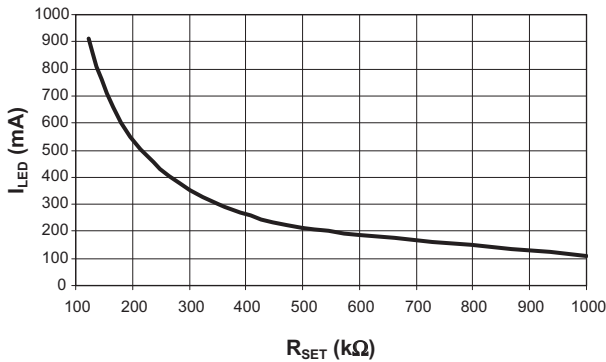

Flash Timer Duration
($C_T = 0.1\mu F$)

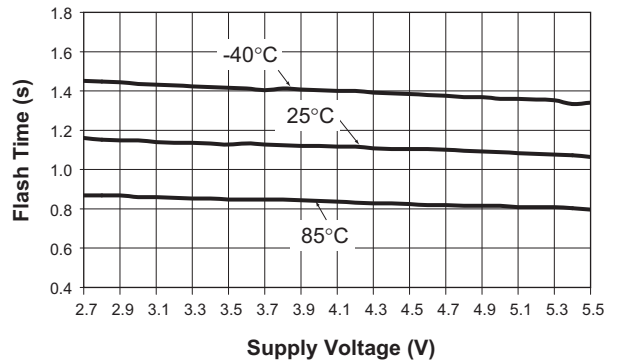

EN/SET Latch Timeout vs. Supply Voltage

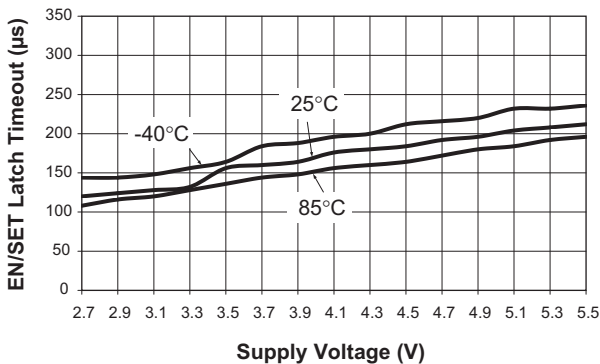

EN/SET Off Timeout vs. Supply Voltage

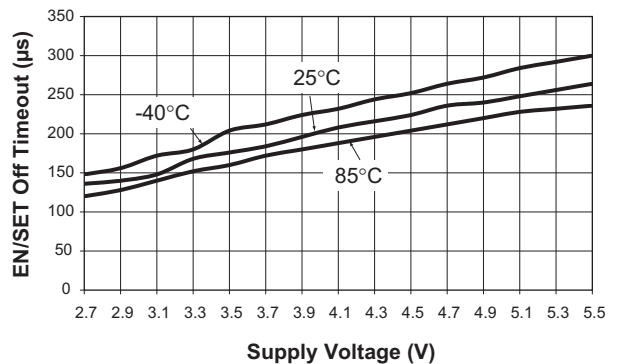

High Current, High Efficiency Charge Pump with Auto-Timer

Typical Characteristics

$V_{IN} = 3.6V$, $C_{IN} = 4.7\mu F$, $C_{OUT} = 2.2\mu F$, $C_1 = C_2 = 1\mu F$, $T_A = 25^\circ C$, unless otherwise noted.

EN/SET High Threshold Voltage vs. Supply Voltage and Temperature

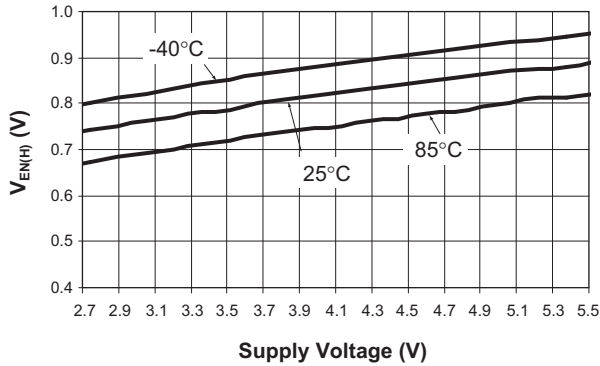

EN/SET Low Threshold Voltage vs. Supply Voltage and Temperature

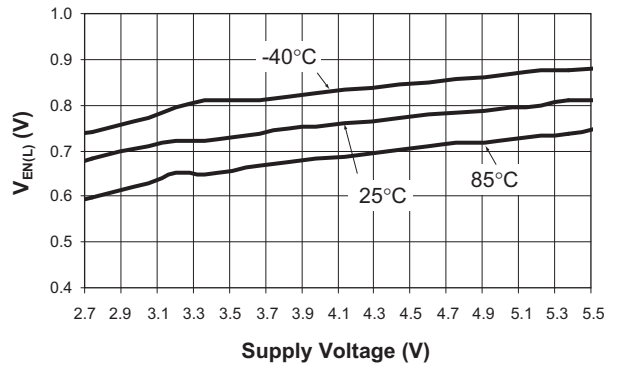

High Current, High Efficiency Charge Pump with Auto-Timer

Functional Block Diagram

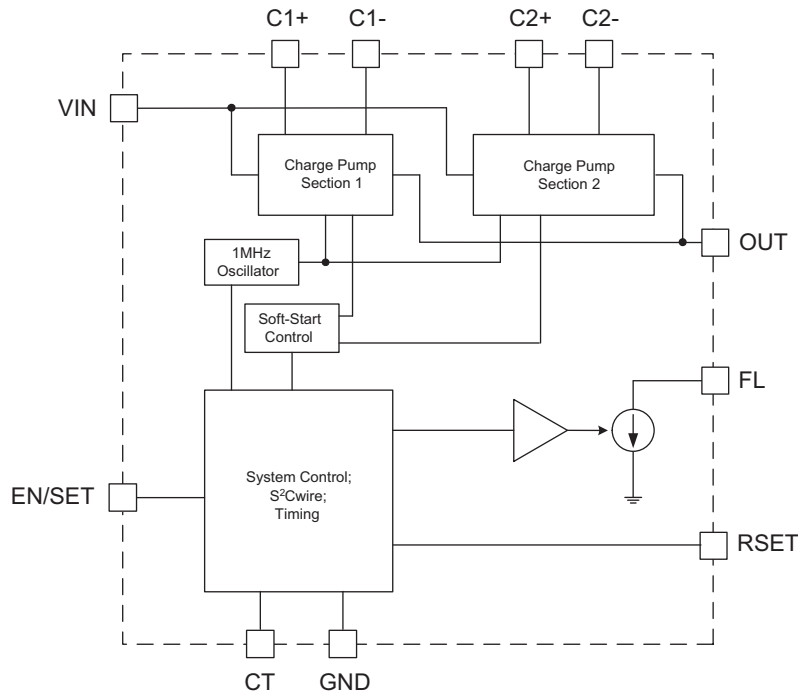

Functional Description

The AAT3171 is a high efficiency, low noise, dual stage tri-mode 1x/1.5x/2x charge pump device intended for photo-flash LED applications. The device requires only four external components: two ceramic capacitors for the charge pump flying capacitors, one ceramic capacitor for C_{IN} , and one ceramic capacitor for C_{OUT} .

The charge pump is designed to deliver regulated load currents up to 800mA. The dual stage charge pump section contains soft-start circuitry to prohibit excessive inrush current during start-up. System efficiency is maximized with a tri-mode, dual stage charge pump topology. The internal clock oscillator at 1MHz allows the use of small external components.

The tri-mode charge pump operation further optimizes power conversion efficiency. Depending upon the variance of load current (at different modes), input voltage, and nominal LED forward voltage, the charge pump will operate in a 1x, 1.5x, or 2x mode to generate the output voltage required to power the load for a given controlled constant current. This results in significant power savings over voltage doubling architectures, especially when

the LEDs are also operated at lower current levels in movie, viewing, or flashlight modes.

S²Cwire Serial Interface

The AAT3171 utilizes Skyworks' single wire S²Cwire interface to enable/disable the charge pump and adjust the output current at 16 current levels. Each code defines the output current to be a percentage of the maximum current set by the resistor at the R_{SET} pin (see Table 1).

The S²Cwire interface records rising edges of the EN/SET pin and decodes them into 16 individual current level settings with Code 1 reserved for maximum current. Once EN/SET has been held in the logic high state for time T_{LAT} (500µs), the programmed current is seen at the current source outputs and the internal data register is reset to 0. For subsequent current level programming, the number of rising edges corresponding to the desired code must be applied on the EN/SET pin.

When EN/SET is held low for an amount of time longer than T_{OFF} (500µs), the AAT3171 enters into shutdown mode and draws less than 1µA from V_{IN} . Data and address registers are reset to 0 during shutdown.

High Current, High Efficiency Charge Pump with Auto-Timer

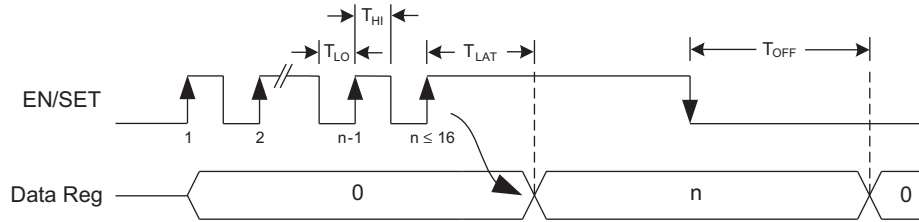

Figure 1: S²Cwire Serial Interface Timing.

Data	Output Current (% of I _{MAX})
1	100.0
2	89.1
3	79.4
4	70.8
5	63.1
6	56.2
7	50.1
8	44.7
9	39.8
10	35.5
11	31.6
12	28.2
13	25.1
14	22.4
15	20.0
16	0.0

Table 1: Current Level Settings.

To disable the auto-timer feature, connect the CT pin to ground. The result will be a small bias current of approximately 3μA. A large valued pull-down resistor should not be used for connecting the CT pin to GND. The CT pin can be connected directly to GND. If a pull-down resistor is preferred, it should be of low value (i.e., less than 10K).

The primary considerations for selecting the capacitor type are leakage current and tolerance of the capacitor value. The auto-timer duration is determined by charging and discharging the timing capacitor with a small charging/discharging current of approximately 3μA. Avoid leaky capacitor types as they will distort the time-out duration. Select the capacitor value's tolerance according to the desired time-out tolerance.

Real-Time Control of the CT Pin

To achieve flash and torch mode control, the auto-timer can be enabled or disabled in real-time. This can be done by connecting a microcontroller or microprocessor GPIO port to the CT pin.

To set up flash mode in real-time, enable the auto-timer by tri-stating the GPIO port. Do not drive the port high. It can only be set to high-impedance so that the CT capacitor can be charged and discharged by the AAT3171.

To set up torch mode in real-time, disable the auto-timer by driving the GPIO port low so that the CT pin will be pulled to GND through the GPIO port.

Application Information

Selecting a Timer Capacitor for CT

The CT pin must be configured according to the desired flash function. There are two options: connect a small valued capacitor or connect the pin to GND.

Configure the timer feature for the AAT3171 by connecting a small valued capacitor between the CT pin and GND. The value of the capacitor will determine the time-out duration according to the following formula:

$$T = C_T \cdot 10 \frac{s}{\mu F}$$

As an example, the result of connecting a 0.1μF capacitor between the CT pin and GND will be a 1 second time-out duration. Operationally, when the AAT3171 is enabled, it will automatically disable itself after 1 second. When using the auto-timer feature, select a CT capacitor value according to the formula above.

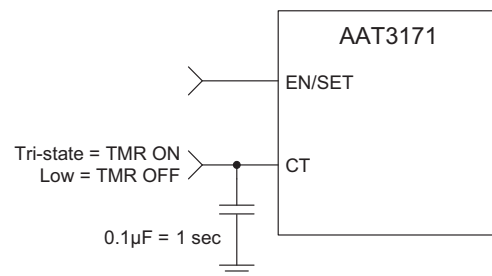

Figure 2: Enable or Disable the Auto-Timer in Real-Time for Flash/Torch Control.

High Current, High Efficiency Charge Pump with Auto-Timer

Flash/Torch Control Using the RSET Pin

An alternative method can be used for flash/torch control that eliminates the need to use the S²Cwire single-wire interface. By using any typical digital I/O port, an additional enable can be created (see Figure 3).

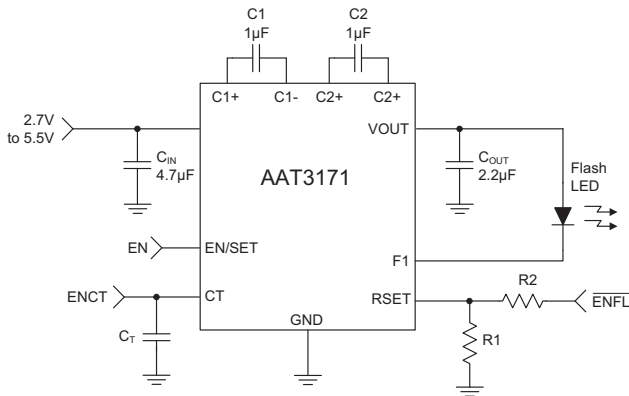

Figure 3: Flash/Torch Control Using the RSET Pin.

The I/O port output configuration can be any one of open-drain NMOS, open-drain PMOS, or push-pull type. The control will always act as an active-low flash enable or, equivalently, an active-high torch enable (see Table 2).

EN	ENFL	Mode
0	0	Off
0	1	Off
1	0	Flash
1	1	Torch

Table 2: Flash/Torch Control Modes.

According to I/O port type, the following equations can be used to calculate appropriate resistor values.

For an open-drain NMOS I/O port output configuration, the line is pulled low to GND or left floating, according to state. To calculate the appropriate R₁ and R₂ resistor values, first calculate the R₁ resistor value needed for the desired torch level LED current:

$$R_1 = \frac{600\text{mA} \cdot 187\text{k}\Omega}{I_{\text{LED}}(\text{torch})}$$

Next, choose R₂ based on the desired flash level LED current:

$$R_2 = \frac{R_1 \cdot 600\text{mA} \cdot 187\text{k}\Omega}{R_1 \cdot I_{\text{LED}}(\text{flash}) - 600\text{mA} \cdot 187\text{k}\Omega}$$

The current and resistance values used in the equations come from the conditions placed on the I_{DX} parameter of the Electrical Characteristics table. For examples of standard 1% values where the LED flash current level is targeted for 700mA, see Table 3.

R ₁ (kΩ)	R ₂ (kΩ)	I _{LED} Torch (mA)	I _{LED} Flash (mA)
920	193	122	703
732	205	153	701
649	210	173	707
562	223	200	703

Table 3: Open-Drain I/O Example Resistor Values.

If the I/O port must be configured as an open-drain PMOS type output, the appropriate equations can be generated from these same concepts. As done in the previous example, the necessary values can then be calculated.

As a reference, the equations applicable to the PMOS case are:

$$R_1 = \frac{600\text{mA} \cdot 187\text{k}\Omega}{I_{\text{LED}}(\text{flash})}$$

$$R_2 = \frac{\frac{V_{\text{IO}}}{0.7} - 1}{\frac{1}{R_1} - \frac{600\text{mA} \cdot 187\text{k}\Omega}{I_{\text{LED}}(\text{torch})}}$$

The value for V_{IO} must come from the I/O supply voltage used in the system. 0.7V is the typical value of the V_{RSET} parameter found in the Electrical Characteristics table.

For a push-pull I/O port output configuration, first calculate the overall R_{SET} value needed for the desired flash level LED current:

$$R_{\text{SET}} = \frac{600\text{mA} \cdot 187\text{k}\Omega}{I_{\text{LED}}(\text{flash})}$$

Next, choose a reasonable value for R₁. A value that is slightly larger than R_{SET}, calculated from above, is appropriate. Calculate R₂ and then calculate the torch mode current level that results:

$$R_2 = \frac{R_{\text{SET}} \cdot R_1}{R_1 - R_{\text{SET}}}$$

$$I_{\text{LED}}(\text{torch}) = 600\text{mA} \cdot 187\text{k}\Omega \cdot \left(\frac{R_2 + R_1}{R_1 \cdot R_2} - \frac{V_{\text{IO}}}{0.7\text{V} \cdot R_2} \right)$$

Once again, the current and resistance values used in

High Current, High Efficiency Charge Pump with Auto-Timer

the equations come from the conditions placed on the I_{DX} parameter of the Electrical Characteristics table. 0.7V is the typical value for the V_{RSET} parameter. The value to use for V_{IO} must come from the I/O supply voltage used in the system.

Example standard 1% values are provided in Table 4.

R_1 (k Ω)	R_2 (k Ω)	I_{LED} Torch (mA)	I_{LED} Flash (mA)
169	1000	95	776
165	1000	111	792
162	1000	124	805
160	1000	132	813

Table 4: Push-Pull I/O Example Resistor Values.

In all of the approaches mentioned, the open-drain NMOS or PMOS type configurations offer the most flexibility for current level selection.

When configured as an output, if the I/O port is only push-pull type, then the equivalent open-drain NMOS can also be realized. To realize this, activate the port as output only when driving the line low. Otherwise, to release the line, set the port to be tri-stated.

Device Power Efficiency

The AAT3171 power conversion efficiency depends on the charge pump mode. By definition, device efficiency is expressed as the output power delivered to the LED divided by the total input power consumed.

$$\eta = \frac{P_{OUT}}{P_{IN}}$$

When the input voltage is sufficiently greater than the LED forward voltage, the device optimizes efficiency by operating in 1x mode. In 1x mode, the device is working as a bypass switch and passing the input supply directly to the output. The power conversion efficiency can be approximated by:

$$\eta = \frac{V_F \cdot I_{LED}}{V_{IN} \cdot I_{IN}} \approx \frac{V_F}{V_{IN}}$$

Due to the very low 1x mode quiescent current, the input current nearly equals the current delivered to the LED. Further, the low-impedance bypass switch introduces negligible voltage drop from input to output.

The AAT3171 further maintains optimized performance and efficiency by detecting when the input voltage is not sufficient to sustain LED current. The device automatically switches to 1.5x mode when the input voltage drops too low in relation to the LED forward voltage.

In 1.5x mode, the output voltage can be boosted to 3/2 the input voltage. The 3/2 conversion ratio introduces a corresponding 1/2 increase in input current. For ideal conversion, the 1.5x mode efficiency is given by:

$$\eta = \frac{V_F \cdot I_{LED}}{V_{IN} \cdot 1.5I_{IN}} = \frac{V_F}{1.5 \cdot V_{IN}}$$

Similarly, when the input falls further, such that 1.5X mode can no longer sustain LED current, the device will automatically switch to 2x mode. In 2x mode, the output voltage can be boosted to twice the input voltage. The doubling conversion ratio introduces a corresponding doubling of the input current. For ideal conversion, the 2x mode efficiency is given by:

$$\eta = \frac{V_F \cdot I_{LED}}{V_{IN} \cdot 2I_{IN}} = \frac{V_F}{2 \cdot V_{IN}}$$

LED Selection

The AAT3171 is designed to drive high-intensity white LEDs. It is particularly suitable for LEDs with an operating forward voltage in the range of 4.2V to 1.5V.

The charge pump device can also drive other loads that have similar characteristics to white LEDs. For various load types, the AAT3171 provides a high-current, programmable ideal constant current source.

Capacitor Selection

Careful selection of the four external capacitors C_{IN} , C_1 , C_2 , and C_{OUT} is important because they will affect turn-on time, output ripple, and transient performance. Optimum performance will be obtained when low equivalent series resistance (ESR) ceramic capacitors are used. In general, low ESR may be defined as less than 100m Ω . A value of 1 μ F for the flying capacitors is a good starting point when choosing capacitors. If the LED current sinks are only programmed for light current levels, then the capacitor size may be decreased.

Ceramic composition capacitors are highly recommended over all other types of capacitors for use with the AAT3171. Ceramic capacitors offer many advantages

High Current, High Efficiency Charge Pump with Auto-Timer

over their tantalum and aluminum electrolytic counterparts. A ceramic capacitor typically has very low ESR, is lowest cost, has a smaller PCB footprint, and is non-polarized. Low ESR ceramic capacitors help maximize charge pump transient response. Since ceramic capacitors are non-polarized, they are not prone to incorrect connection damage.

Equivalent Series Resistance

ESR is an important characteristic to consider when selecting a capacitor. ESR is a resistance internal to a capacitor that is caused by the leads, internal connections, size or area, material composition, and ambient temperature. Capacitor ESR is typically measured in milliohms for ceramic capacitors and can range to more than several ohms for tantalum or aluminum electrolytic capacitors.

Ceramic Capacitor Materials

Ceramic capacitors less than $0.1\mu\text{F}$ are typically made from NPO or COG materials. NPO and COG materials generally have tight tolerance and are very stable over temperature. Larger capacitor values are usually composed of X7R, X5R, Z5U, or Y5V dielectric materials. Large ceramic capacitors are often available in lower-cost dielectrics, but capacitors greater than $4.7\mu\text{F}$ are not typically required for AAT3171 applications.

Capacitor area is another contributor to ESR. Capacitors that are physically large will have a lower ESR when compared to an equivalent material smaller capacitor. These larger devices can improve circuit transient response when compared to an equal value capacitor in a smaller package size.

Thermal Protection

The AAT3171 has a thermal protection circuit that will shut down the charge pump if the die temperature rises above the thermal limit, as is the case during a short-circuit of the OUT pin.

PCB Layout

To achieve adequate electrical and thermal performance, careful attention must be given to the PCB layout. In the worst-case operating condition, the chip must dissipate considerable power at full load. Adequate heat-sinking must be achieved to ensure intended operation.

Figure 4 illustrates an example of an adequate PCB lay-

out. The bottom of the package features an exposed metal paddle. The exposed paddle acts, thermally, to transfer heat from the chip and, electrically, as a ground connection.

The junction-to-ambient thermal resistance (θ_{JA}) for the package can be significantly reduced by following a couple of important PCB design guidelines.

The PCB area directly underneath the package should be plated so that the exposed paddle can be mated to the top layer PCB copper during the re-flow process. This area should also be connected to the top layer ground pour when available. Further, multiple copper plated thru-holes should be used to electrically and thermally connect the top surface paddle area to additional ground plane(s) and/or the bottom layer ground pour.

The chip ground is internally connected to both the paddle and the GND pin. The GND pin conducts large currents and it is important to minimize any differences in potential that can result between the GND pin and exposed paddle. It is good practice to connect the GND pin to the exposed paddle area using a trace as shown in Figure 4.

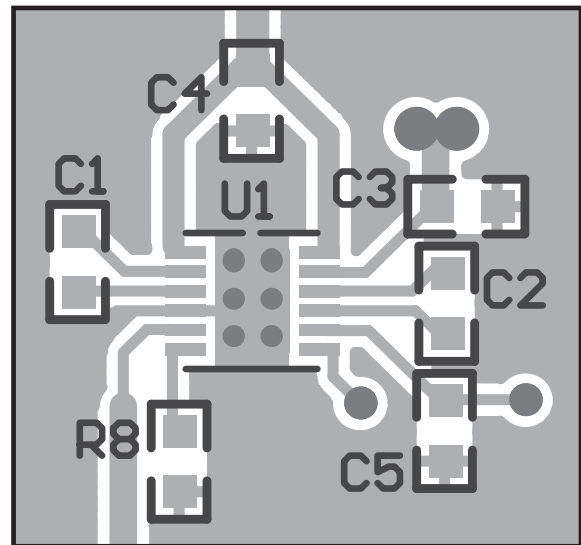

Figure 4: Example PCB Layout.

The flying capacitors C1 and C2 should be connected close to the chip. Trace length should be kept short to minimize path resistance and potential coupling. The input and output capacitors should also be placed as close to the chip as possible.

High Current, High Efficiency Charge Pump with Auto-Timer

Evaluation Board User Interface

The user interface for the AAT3171 evaluation board is provided by 3 buttons and a couple of connection terminals. The board is operated by supplying external power and pressing individual buttons or button combinations. The table below indicates the function of each button or button combination.

To power-on the evaluation board, connect a power supply or battery to the DC- and DC+ terminals. Make the board's supply connection by positioning the J1 jumper to the ON position. A red LED indicates that power is applied.

The evaluation board is made flexible so that the user can disconnect the enable line from the microcontroller and apply an external enable signal. By removing the jumper from J2, an external enable signal can be applied to the board. Apply the external enable signal to the ON pin of the J2 terminal.

When applying an external enable signal, consideration must be given to the voltage level. The externally applied voltage cannot exceed the supply voltage that is applied to the VIN pins of the device (i.e., DC+).

Button(s) Pushed ^{1, 2}	Description
DATA	Increments through the 16 data settings. Hold-down to auto-cycle.
MOVIE+DATA	Decrement the data setting. Hold-down to auto-cycle.
FLASH	Generate a flash pulse. Current level determined by the DATA setting (defaults to DATA 1). Trim-pot VR4 sets timeout duration.
MOVIE	Toggle on/off movie mode illumination. Current level determined by the DATA setting. Leave on to see effects of changing DATA.
DATA+FLASH+MOVIE	Reset, shutdown.

Table 5: Evaluation Board User Interface.

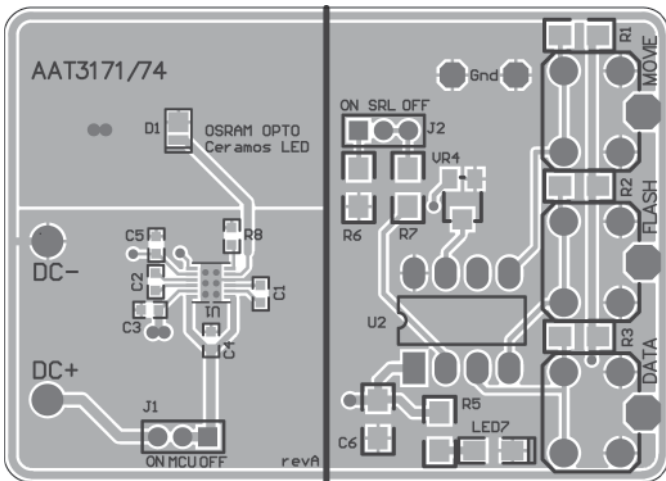

Figure 5: AAT3171 Evaluation Board Top Side Layout.

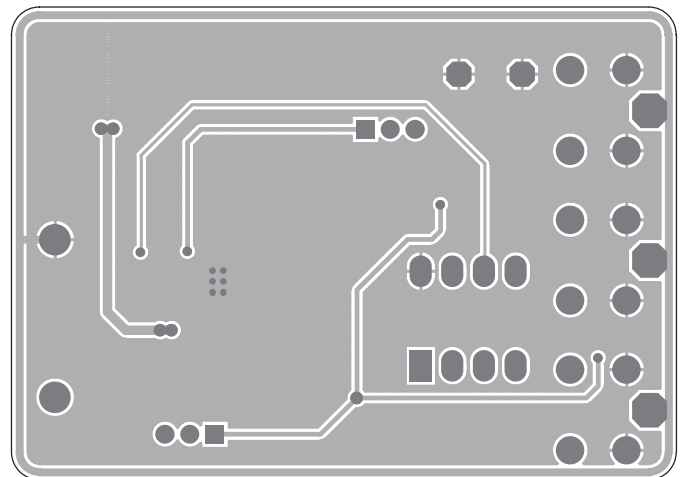

Figure 6: AAT3171 Evaluation Board Bottom Side Layout.

1. The '+' sign indicates that these buttons are all pressed and released together.
 2. Flash timeout duration is adjustable from 10ms to 2 seconds. Rotate trim pot VR4 clockwise to reduce the duration. When the timeout duration determined by the value of C₁ is set to be less than the VR4 setting, it will supersede.

High Current, High Efficiency Charge Pump with Auto-Timer

Evaluation Board Schematic

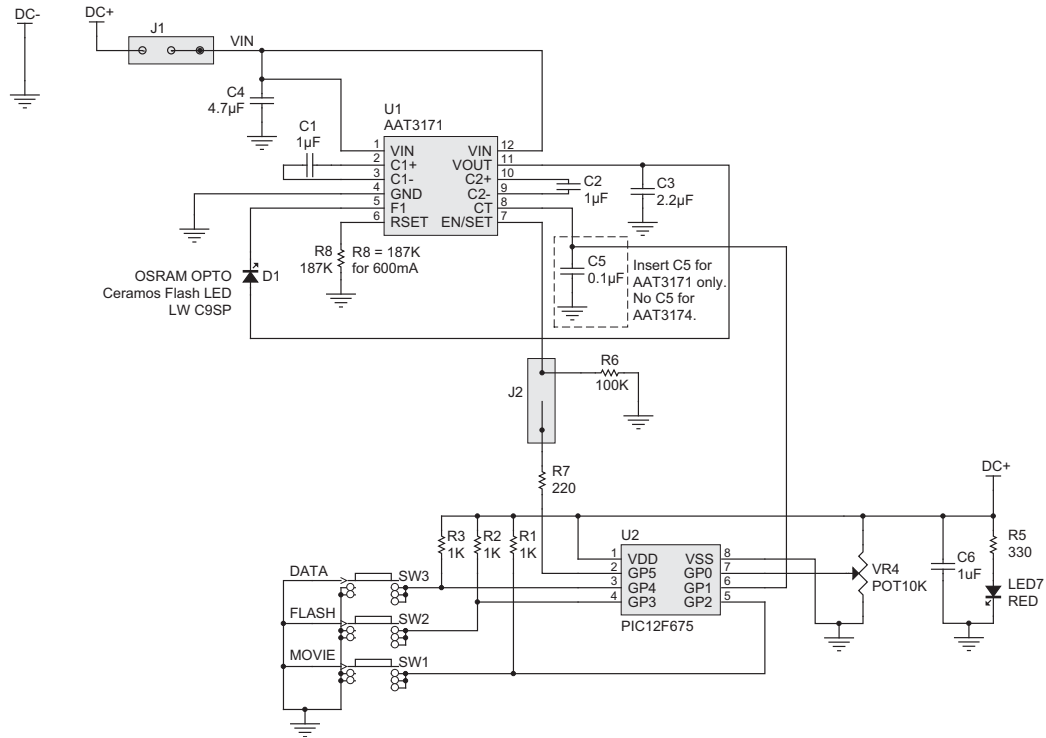

Figure 7: AAT3171 Evaluation Board Schematic.

Evaluation Board Component Listing

Component	Part Number	Description	Manufacturer
U1	AAT3171	Tri-Mode High Eff. CP for White LED Flash; DFN33-12 Package	Skyworks
U2	PIC12F675	8-bit CMOS, FLASH-based µC; 8-pin PDIP Package	Microchip
D1	LW C9SP	Ceramos TopLooker, High Brightness Flash LED	OSRAM OPTO
R1 - R3	Chip Resistor	1K, 5%, 1/4W; 1206	Vishay
C1 - C2	GRM18x	1.0µF, 10V, X5R, 0603, Ceramic	Murata
C3	GRM18x	2.2µF, 10V, X5R, 0603, Ceramic	Murata
C4	GRM18x	4.7µF, 6.3V, X5R, 0603, Ceramic	Murata
C5	GRM18x	0.1µF, 16V, X7R, 0603, Ceramic	Murata
C6	GRM31x	1.0µF, 10V, X5R, 1206, Ceramic	Murata
R5	Chip Resistor	330, 5%, 1/4W; 1206	Vishay
R6	Chip Resistor	100K, 5%, 1/4W; 1206	Vishay
R7	Chip Resistor	220, 5%, 1/4W; 1206	Vishay
R8	Chip Resistor	187K, 1%, 1/10W; 0603	Vishay
VR4	EVN-5ESX50B14	10K POT; 3mm Squared SMD	Panasonic-ECG
LED7	CMD15-21SRC/TR8	Red LED; 1206	Chicago Miniature Lamp
J1 - J2	PRPN401PAEN	Conn. Header, 2mm	Sullins Electronics
SW1 - SW3	PTS645TL50	Switch Tact, SPST, 5mm	ITT Industries

High Current, High Efficiency Charge Pump with Auto-Timer

Ordering Information

Package	Marking ¹	Part Number (Tape and Reel) ²
TDFN33-12	TAXYY	AAT3171IWP-T1



Skyworks Green™ products are compliant with all applicable legislation and are halogen-free.



For additional information, refer to *Skyworks Definition of Green™*, document number SQ04-0074.

Package Information³

TDFN33-12

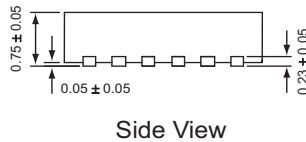
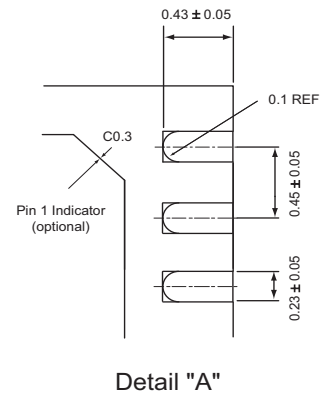
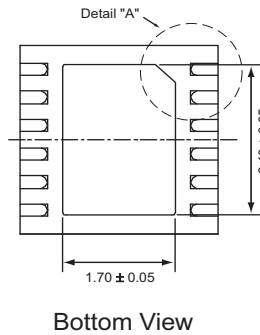
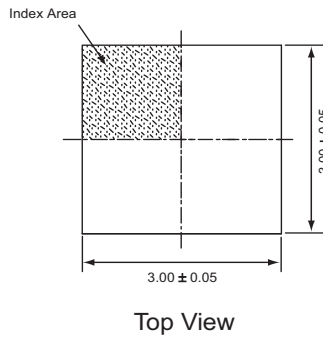

All dimensions in millimeters.

1. XYY = assembly and date code.
2. Sample stock is generally held on part numbers listed in **BOLD**.
3. The leadless package family, which includes QFN, TQFN, DFN, TDFN and STDN, has exposed copper (unplated) at the end of the lead terminals due to the manufacturing process. A solder fillet at the exposed copper edge cannot be guaranteed and is not required to ensure a proper bottom solder connection.

High Current, High Efficiency Charge Pump with Auto-Timer

Copyright © 2012 Skyworks Solutions, Inc. All Rights Reserved.

Information in this document is provided in connection with Skyworks Solutions, Inc. ("Skyworks") products or services. These materials, including the information contained herein, are provided by Skyworks as a service to its customers and may be used for informational purposes only by the customer. Skyworks assumes no responsibility for errors or omissions in these materials or the information contained herein. Skyworks may change its documentation, products, services, specifications or product descriptions at any time, without notice. Skyworks makes no commitment to update the materials or information and shall have no responsibility whatsoever for conflicts, incompatibilities, or other difficulties arising from any future changes.

No license, whether express, implied, by estoppel or otherwise, is granted to any intellectual property rights by this document. Skyworks assumes no liability for any materials, products or information provided hereunder, including the sale, distribution, reproduction or use of Skyworks products, information or materials, except as may be provided in Skyworks Terms and Conditions of Sale.

THE MATERIALS, PRODUCTS AND INFORMATION ARE PROVIDED "AS IS" WITHOUT WARRANTY OF ANY KIND, WHETHER EXPRESS, IMPLIED, STATUTORY, OR OTHERWISE, INCLUDING FITNESS FOR A PARTICULAR PURPOSE OR USE, MERCHANTABILITY, PERFORMANCE, QUALITY OR NON-INFRINGEMENT OF ANY INTELLECTUAL PROPERTY RIGHT; ALL SUCH WARRANTIES ARE HEREBY EXPRESSLY DISCLAIMED. SKYWORKS DOES NOT WARRANT THE ACCURACY OR COMPLETENESS OF THE INFORMATION, TEXT, GRAPHICS OR OTHER ITEMS CONTAINED WITHIN THESE MATERIALS. SKYWORKS SHALL NOT BE LIABLE FOR ANY DAMAGES, INCLUDING BUT NOT LIMITED TO ANY SPECIAL, INDIRECT, INCIDENTAL, STATUTORY, OR CONSEQUENTIAL DAMAGES, INCLUDING WITHOUT LIMITATION, LOST REVENUES OR LOST PROFITS THAT MAY RESULT FROM THE USE OF THE MATERIALS OR INFORMATION, WHETHER OR NOT THE RECIPIENT OF MATERIALS HAS BEEN ADVISED OF THE POSSIBILITY OF SUCH DAMAGE.

Skyworks products are not intended for use in medical, lifesaving or life-sustaining applications, or other equipment in which the failure of the Skyworks products could lead to personal injury, death, physical or environmental damage. Skyworks customers using or selling Skyworks products for use in such applications do so at their own risk and agree to fully indemnify Skyworks for any damages resulting from such improper use or sale.

Customers are responsible for their products and applications using Skyworks products, which may deviate from published specifications as a result of design defects, errors, or operation of products outside of published parameters or design specifications. Customers should include design and operating safeguards to minimize these and other risks. Skyworks assumes no liability for applications assistance, customer product design, or damage to any equipment resulting from the use of Skyworks products outside of stated published specifications or parameters.

Skyworks, the Skyworks symbol, and "Breakthrough Simplicity" are trademarks or registered trademarks of Skyworks Solutions, Inc., in the United States and other countries. Third-party brands and names are for identification purposes only, and are the property of their respective owners. Additional information, including relevant terms and conditions, posted at www.skyworksinc.com, are incorporated by reference.