

DATA SHEET

SE2521A60: 2.4 GHz Wireless LAN Front-End

Applications

- IEEE802.11b DSSS WLAN
- IEEE802.11g OFDM WLAN
- Access Points, PCMCIA, PC cards

Features

- Pin for pin compatible to Skyworks' SE2521A34 but providing 2 dB extra output power
- Dual Mode IEEE802.11b & IEEE802.11g
- All RF ports matched to 50 Ω
- Integrated PA, TX Filter, DPDT T/R and Diversity switches
- Integrated Power Detector
- 23 dBm O/P Power, 802.11b, 11 Mbits, ACPR <- 35 dBc
- 18 dBm @ 2.0 %, 802.11g, 54 Mbits
- Single supply voltage: 3.3 V ± 10 %
- Lead free and RoHS compliant
- Small lead free plated package, 8 mm x 7 mm x 1.1 mm, MSL 3

Product Description

The SE2521A60 is a complete 802.11 b/g WLAN RF front-end module providing all the functionality of the power amplifier, power detector, T/R switch, diversity switch and associated matching. The SE2521A60 provides a complete 2.4 GHz WLAN RF solution from the output of the transceiver to the antennas in an ultra compact form factor.

Designed for ease of use, all RF ports are matched to 50 Ω to simplify PCB layout and the interface to the transceiver RFIC. The SE2521A60 also includes a transmitter power detector with 20 dB of dynamic range and a digital enable control for transmitter power ramp on/off control. The power ramp rise/fall time is 1 μsec typical.

The device also provides a notch filter from 3.2-3.3 GHz prior to the input of the power amplifier.

The SE2521A60 is footprint compatible to Skyworks' SE2521A34 and can be placed directly into existing SE2521A34 designs easily providing higher output power solutions

Ordering Information

Part No.	Package	Remark
SE2521A60	24 pin LGA	Samples
SE2521A60-R	24 pin LGA	Tape and Reel
SE2521A60-EK1	N/A	Evaluation kit

DATA SHEET
SE2521A60: 2.4 GHz Wireless LAN Front-End

Functional Block Diagram

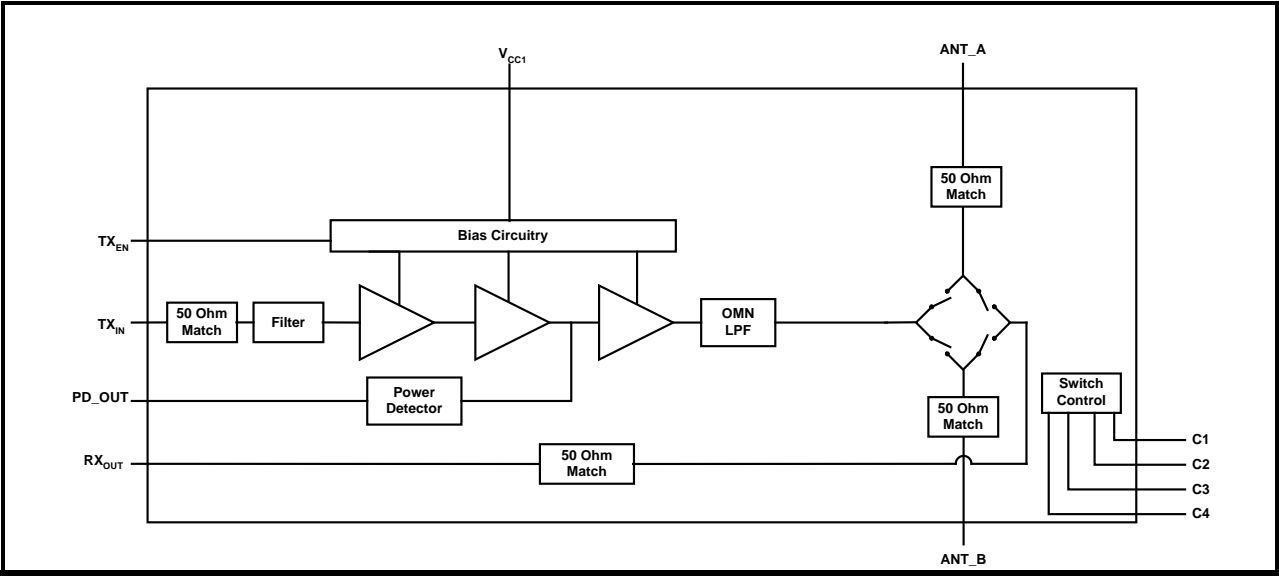

Figure 1: Functional Block Diagram

DATA SHEET

SE2521A60: 2.4 GHz Wireless LAN Front-End

Pin Out Diagram

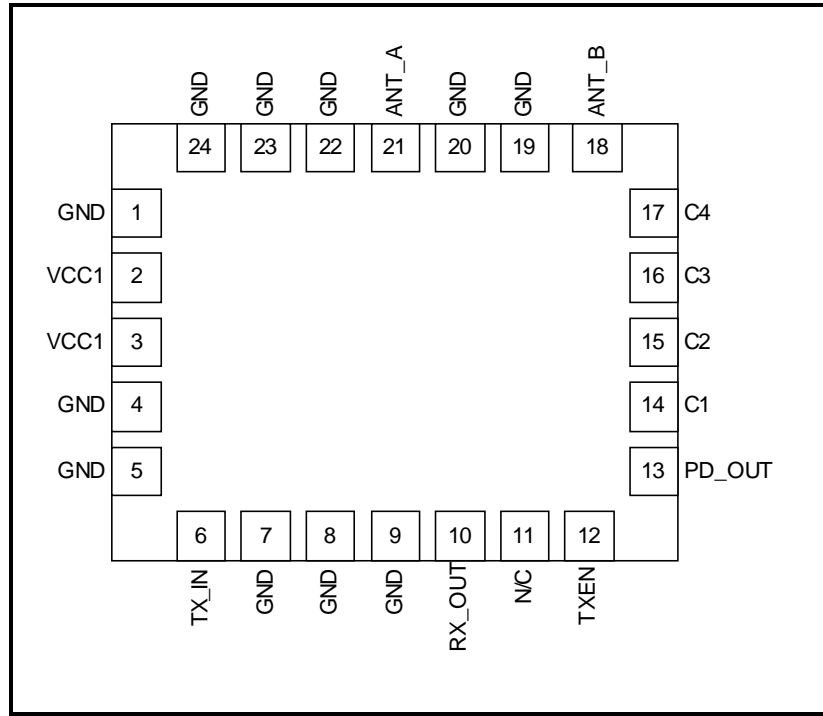

Figure 2: SE2521A60 Pin Out (Top View Through Package)

Pin Out Description

Pin No.	Name	Description
1	GND	Ground
2	VCC1	+3.3 V DC
3	VCC1	+3.3 V DC
4,5	GND	Ground
6	TX_IN	Transmit Input
7,8,9	GND	Ground
10	RX_OUT	Receive Output
11	N/C	No Connect
12	TXEN	Transmit Enable
13	PD_OUT	Power Detector
14	C1	Control 1 Input
15	C2	Control 2 Input
16	C3	Control 3 Input
17	C4	Control 4 Input
18	ANT_B	Antenna B (50 ohm)

DATA SHEET

SE2521A60: 2.4 GHz Wireless LAN Front-End

Pin No.	Name	Description
19,20	GND	Ground
21	ANT_A	Antenna A (50 ohm)
22,23,24	GND	Ground

Absolute Maximum Ratings

These are stress ratings only. Exposure to stresses beyond these maximum ratings may cause permanent damage to, or affect the reliability of the device. Avoid operating the device outside the recommended operating conditions defined below. This device is ESD sensitive. Handling and assembly of this device should be at ESD protected workstations.

Symbol	Definition	Min.	Max.	Unit
V _{CC}	Supply Voltage on V _{CC}	-0.3	4.0	V
TX _{EN}	Power Amplifier Enable	-0.3	4.0	V
TX _{RF}	RF Input Power	-	2.0	dBm
T _A	Operating Temperature Range	-20	85	°C
T _{STG}	Storage Temperature Range	-40	150	°C

Recommended Operating Conditions

Symbol	Parameter	Min.	Typ.	Max.	Unit
V _{CC}	Supply Voltage	3.0	3.3	3.6	V
T _A	Ambient Temperature	0	25	85	°C

DC Electrical Characteristics

Conditions: V_{CC} = V_{EN} = 3.3 V, T_A = 25 °C, as measured on Skyworks Solutions' SE2521A60-EV1 evaluation board (de-embedded to device), all unused ports terminated with 50 ohms, unless otherwise noted

Symbol	Parameter	Conditions	Min.	Typ.	Max.	Unit
I _{CC-G}	Total Supply Current	P _{OUT} = 18 dBm, 54 Mbps OFDM signal, 64QAM	165	180	230	mA
		P _{OUT} = 15 dBm, 54 Mbps OFDM signal, 64QAM	110	150	215	mA
I _{CC-B}	Total Supply Current	P _{OUT} = 20 dBm, 11 Mbps CCK signal, BT = 0.45	175	205	275	mA
I _{CC-OFF}	Total Supply Current	V _{EN} = 0 V, No RF Applied, C1 = C2 = C3 = C4 = 0 V	-	2	10	µA

DATA SHEET

SE2521A60: 2.4 GHz Wireless LAN Front-End

Logic Characteristics

Conditions: $V_{CC} = V_{EN} = 3.3\text{ V}$, $T_A = 25\text{ }^\circ\text{C}$, as measured on Skyworks Solutions' SE2521A60-EV1 evaluation board (de-embedded to device), all unused ports terminated with 50 ohms, unless otherwise noted.

Symbol	Parameter	Conditions	Min.	Typ.	Max.	Unit
V_{ENH}	Logic High Voltage (Module On)	-	2.0	-	V_{CC}	V
V_{ENL}	Logic Low Voltage (Module Off)	-	0	-	0.5	V
I_{ENH}	Input Current Logic High Voltage	-	-1	-	200	μA
I_{ENL}	Input Current Logic Low Voltage	-	-1	-	1	μA

Switch Characteristics

Conditions: $V_{CC} = V_{EN} = 3.3\text{ V}$, $T_A = 25\text{ }^\circ\text{C}$, as measured on Skyworks Solutions' SE2521A60-EV1 evaluation board (de-embedded to device), all unused ports terminated with 50 ohms, unless otherwise noted.

Symbol	Parameter	Conditions	Min.	Typ.	Max.	Unit
V_{CTL_ON}	Control Voltage (On State)	-	3.0	-	3.6	V
V_{CTL_OFF}	Control Voltage (OFF State)	-	0.0	-	0.2	V
SW_{ON}	Low Loss Switch Control Voltage	High State = $V_{CTL_ON} - V_{CTL_OFF}$	2.8	-	V_{CC}	V
SW_{OFF}	High Loss Switch Control Voltage	Low State = $V_{CTL_OFF} - V_{CTL_OFF}$	0	-	0.3	V
I_{CTL_ON}	Switch Control Bias Current (RF Applied)	On pin (C1,C2,C3,C4) being driven high. RF Applied	-	-	100	μA
I_{CTL_ON}	Switch Control Bias Current (No RF)	On pin (C1,C2,C3,C4) being driven high. No RF	-	-	30	μA
C_{CTL}	Control Input Capacitance	-	-	-	100	pF

Switch Control Logic Table

Switch Logic				Operational Mode			
C1	C4	C2	C3	$TX_{RF} - ANTA$	$TX_{RF} - ANTB$	$RX_{RF} - ANTA$	$RX_{RF} - ANTB$
SW_{ON}	SW_{OFF}	SW_{OFF}	SW_{OFF}	ON	OFF	OFF	OFF
SW_{OFF}	SW_{ON}	SW_{OFF}	SW_{OFF}	OFF	ON	OFF	OFF

DATA SHEET

SE2521A60: 2.4 GHz Wireless LAN Front-End

Switch Logic				Operational Mode			
C1	C4	C2	C3	TX _{RF} – ANTA	TX _{RF} – ANTB	RX _{RF} – ANTA	RX _{RF} – ANTB
SW _{OFF}	SW _{OFF}	SW _{ON}	SW _{OFF}	OFF	OFF	ON	OFF
SW _{OFF}	SW _{OFF}	SW _{OFF}	SW _{ON}	OFF	OFF	OFF	ON

AC Electrical Characteristics

802.11g Transmit Characteristics

Conditions: V_{CC} = V_{EN} = 3.3 V, T_A = 25 °C, as measured on Skyworks Solutions' SE2521A60-EV1 evaluation board (de-embedded to device), all unused ports terminated with 50 ohms, unless otherwise noted.

Symbol	Parameter	Condition	Min.	Typ.	Max.	Unit
F _{IN}	Frequency Range	-	2400	-	2500	MHz
P _{802.11g}	Output power	54 Mbps OFDM signal, 64QAM, EVM = 2.0 %	-	18	-	dBm
P _{802.11b}	Output power	11 Mbps CCK signal, BT = 0.45 ACPR(Adj) < -32 ACPR(Alt) < -52	-	23	-	dBm
P _{1dB}	P1dB	-	22.5	25.5	-	dBm
S ₂₁	Small Signal Gain	-	25	-	33	dB
ΔS ₂₁	Small Signal Gain Variation Over Band	-	-	1.0	3.0	dB
S ₂₁ 3.2	Gain @ 3.2 to 3.3 GHz	-	-	0	7	dB
2f,3f	Harmonics	P _{out} = 19 dBm, 2 Mbps, 802.11b CCK	-	-49	-42	dBm/MHz
IM3	3 rd Order Inter-modulation	f1 and f2 at F _c +/- 312.5 kHz, P = 15 dBm	-	-40	-33	dBc
IM5	5 th Order Inter-modulation	f1 and f2 at F _c +/- 312.5 kHz, P = 15 dBm	-	-55	-47	dBc
t _r	Rise Time	10 % to 90% of final output power level	-	0.12	0.5	μs
t _{dr} , t _{df}	Delay and rise/fall Time	50 % of V _{EN} edge and 90/10 % of final output power level	-	-	1.0	μs
S ₁₁	Input Return Loss	-	4.5	6.5	-	dB
STAB	Stability	P _{IN} ≤ -2 dBm Load VSWR = 6:1	All non-harmonically related outputs less than -50 dBc/1MHz			

DATA SHEET

SE2521A60: 2.4 GHz Wireless LAN Front-End

Receive Characteristics

Conditions: $V_{CC} = V_{EN} = 3.3\text{ V}$, $T_A = 25\text{ }^\circ\text{C}$, as measured on Skyworks Solutions' SE2521A60-EV1 evaluation board (de-embedded to device), all unused ports terminated with 50 ohms, unless otherwise noted.

Symbol	Parameter	Condition	Min.	Typ.	Max.	Unit
F _{OUT}	Frequency Range	-	2400	-	2500	MHz
RX _{IL}	Insertion Loss	-	-	0.8	1.2	dB
RX _{RL}	Return Loss	-	-	-15	-10	dB
Delta Rx	Delta between Rx paths	ANT_A to RX_OUT or ANT_B to RX_OUT	-	-	0.5	dB
TR _{ISOL-2}	Rx Leakage	C1 or C4 = SWON, C2 = C3 = SWOFF, Device transmitting 15 dBm @ ANTA or ANTB, Power measured @ RX_OUT	-9	-	3	dBm
ANTR _{ISOL}	Isolation between ANT_A and ANT_B to RX_OUT	Small signal input into ANT_A or ANT_B, Device not transmitting, Power measured @ RX_OUT, C1 AND C4 = SWON, C2 and C3 = SWOFF	14	-	24	dB

Power Detector Characteristics

Conditions: $V_{CC} = V_{EN} = 3.3\text{ V}$, $T_A = 25\text{ }^\circ\text{C}$, as measured on Skyworks Solutions' SE2521A60-EV1 evaluation board (de-embedded to device), unless otherwise noted.

Symbol	Parameter	Condition	Min.	Typ.	Max.	Unit
F _{OUT}	Frequency Range	-	2400	-	2500	MHz
PDR	Power detect range, peak power	Measured at ANT_A or ANT_B	0	-	20	dBm
PDZ _{LOAD}	DC load impedance	-	1	-	-	Mohm
PDV _{NoRF}	Output Voltage, P _{OUT} = No RF	-	0.90	-	1.02	V
PDV _{p18}	Output Voltage, P _{OUT} = 18dBm	-	0.44	-	0.66	V
PDV _{p20}	Output Voltage, P _{OUT} = 20dBm	-	0.28	-	0.51	V
LPF _{-3dB}	Power detect low pass filter -3dB corner frequency	PDZ _{LOAD} = >1 Mohm, PDC _{LOAD} = 180 pF	270	330	400	KHz

Note: Power detector internal impedance is 2.7 KOhm

DATA SHEET

SE2521A60: 2.4 GHz Wireless LAN Front-End

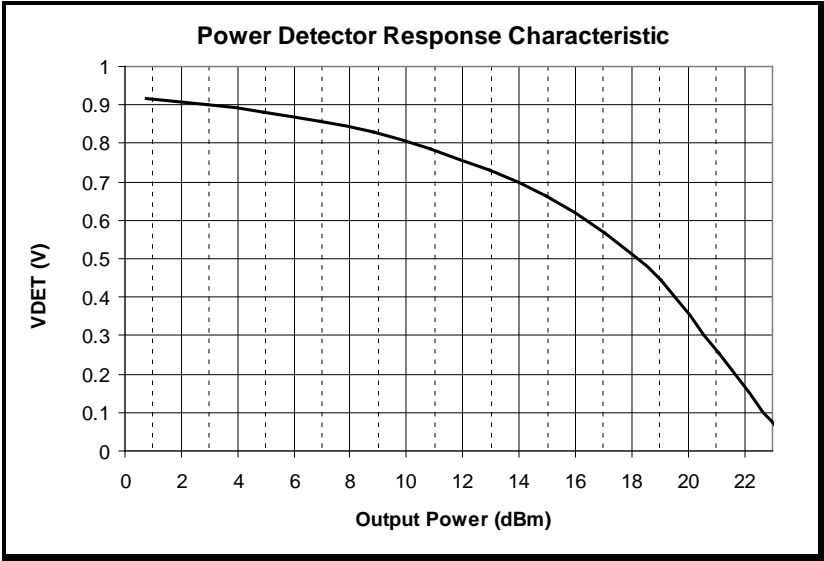

Figure 3: SE2521A60 Power Detector Performance Curve

Typical Performance Data (Ambient Temperature)

Conditions: $V_{CC} = V_{EN} = 3.3\text{ V}$, Frequency = 2450 MHz, $T_A = 25\text{ }^\circ\text{C}$, as measured on Skyworks Solutions' SE2521A60-EV1 evaluation board, all unused ports terminated with 50 ohms, unless otherwise noted.

802.11g Typical Performance

Conditions: 54Mbps 802.11g OFDM Signal

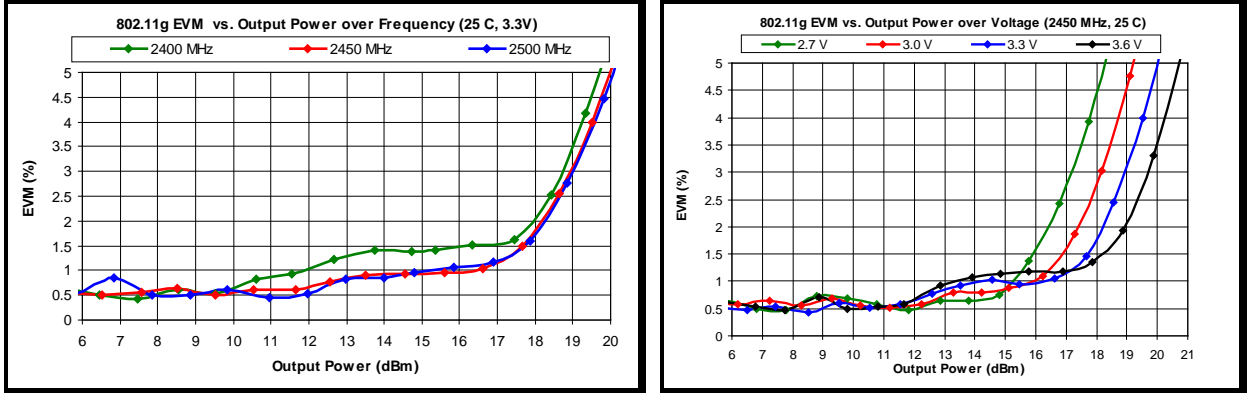

Figure 4: 802.11g Typical EVM Performance: (a) Over Frequency, (b) Over Voltage

DATA SHEET

SE2521A60: 2.4 GHz Wireless LAN Front-End

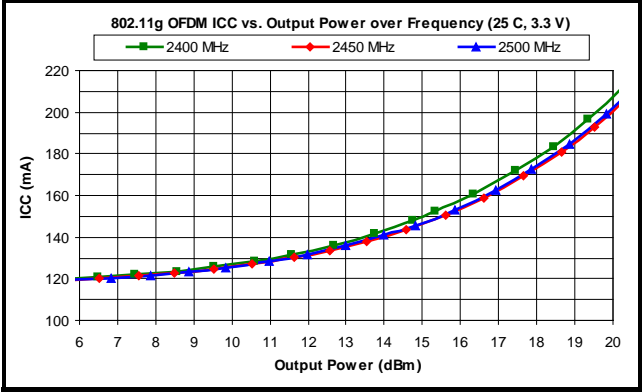

Figure 5: 802.11g Typical Current Consumption (ICC) Performance over Frequency

802.11b Typical Performance

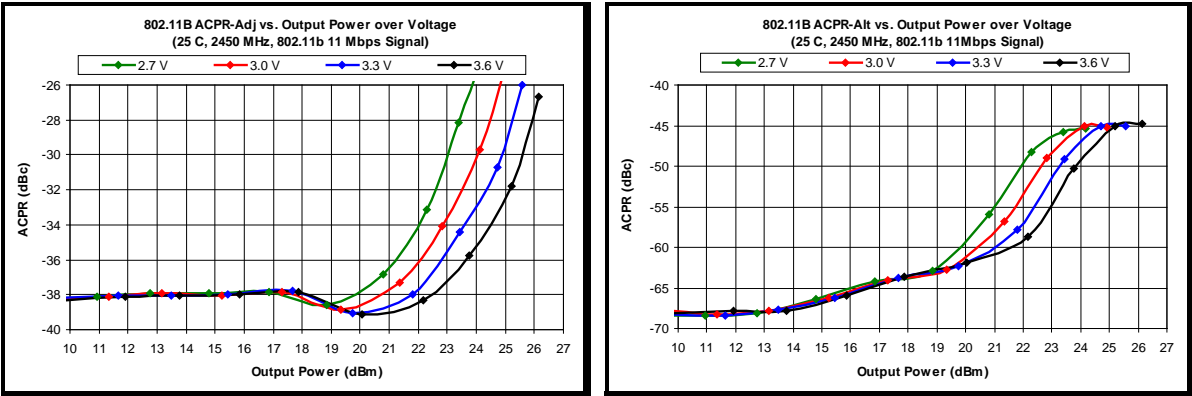

Figure 6: 802.11b Typical ACPR Performance (11 Mbps, CCK, BT = 0.45) (a) 802.11b ACPR-ADJ vs. POUT over Voltage and (b) 802.11b ACPR-ALT vs. POUT over Voltage

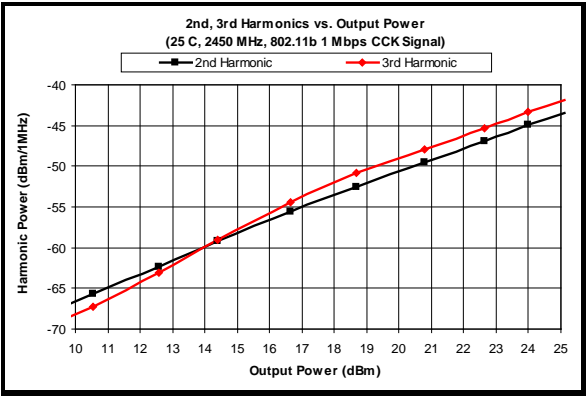

Figure 7: 802.11b Typical Harmonic Performance (1 Mbps, CCK)

CW Typical Performance

DATA SHEET
SE2521A60: 2.4 GHz Wireless LAN Front-End

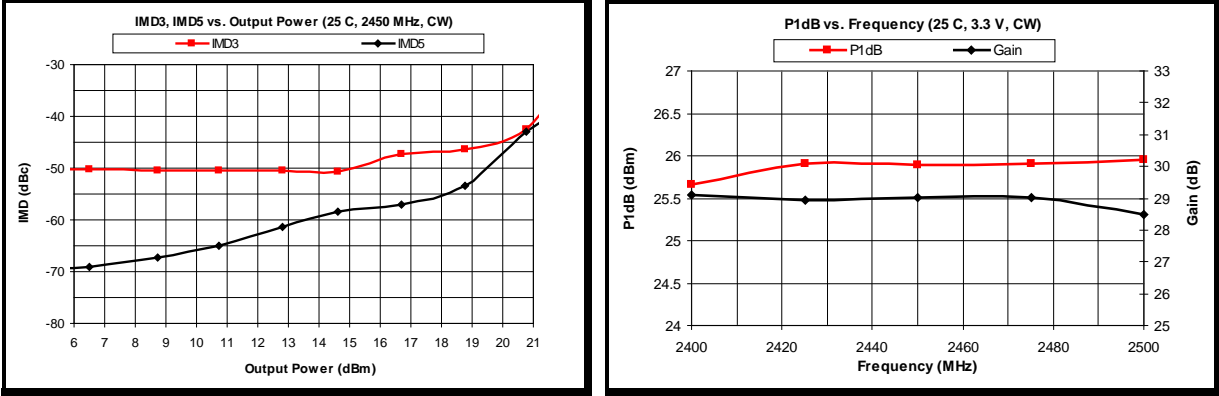

Figure 8: Typical CW Performance (a) IMD3, IMD5 vs. Output Power, (b) P1dB, Gain vs. Frequency

Detector Performance

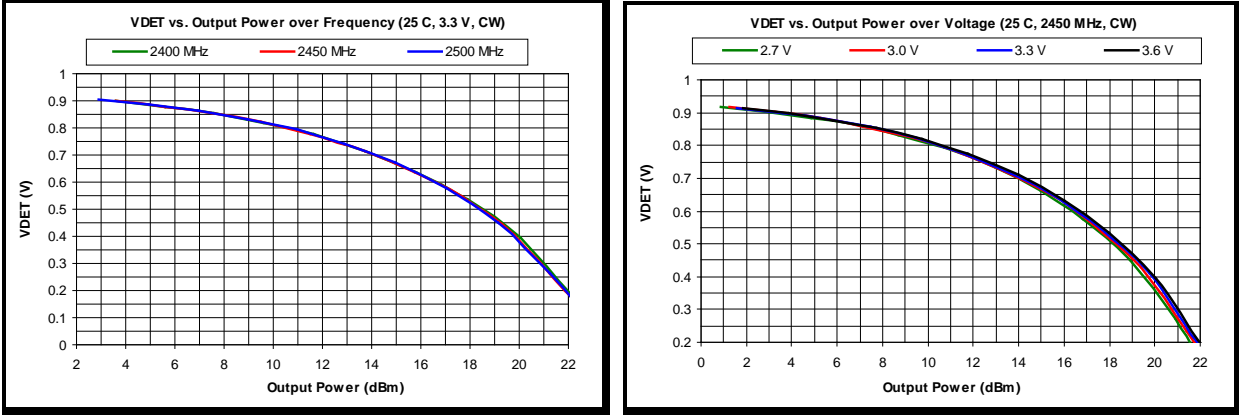

Figure 9: Typical Power Detector Response: (a) Over Frequency, (b) Over Voltage

DATA SHEET

SE2521A60: 2.4 GHz Wireless LAN Front-End

Typical Performance Data (Over Temperature: -40 C, 25 C, 85 C)

Conditions: $V_{CC} = V_{EN} = 3.3 V$, Frequency = 2450 MHz, as measured on Skyworks Solutions' SE2521A60-EV1 evaluation board, all unused ports terminated with 50 ohms, unless otherwise noted.

802.11g Typical Performance

Conditions: 54Mbps 802.11g OFDM Signal

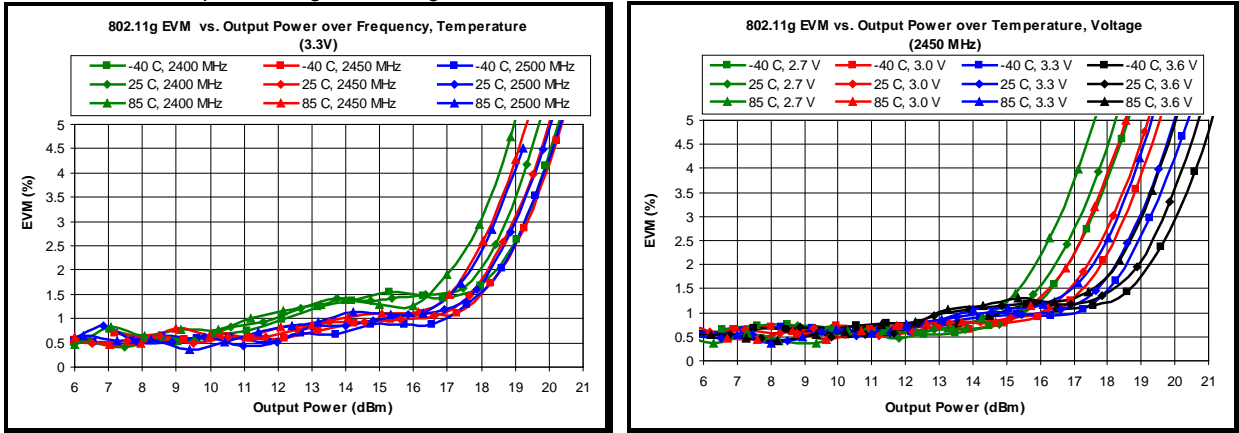

Figure 10: 802.11g Typical EVM Performance: (a) Over Frequency and Temperature, (b) Over Voltage and Temperature

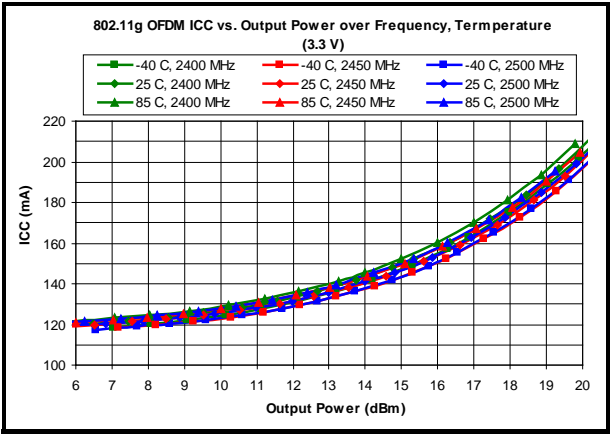

Figure 11: 802.11g Typical Current Consumption (ICC) Performance over Frequency and Temperature

DATA SHEET

SE2521A60: 2.4 GHz Wireless LAN Front-End

802.11b Typical Performance

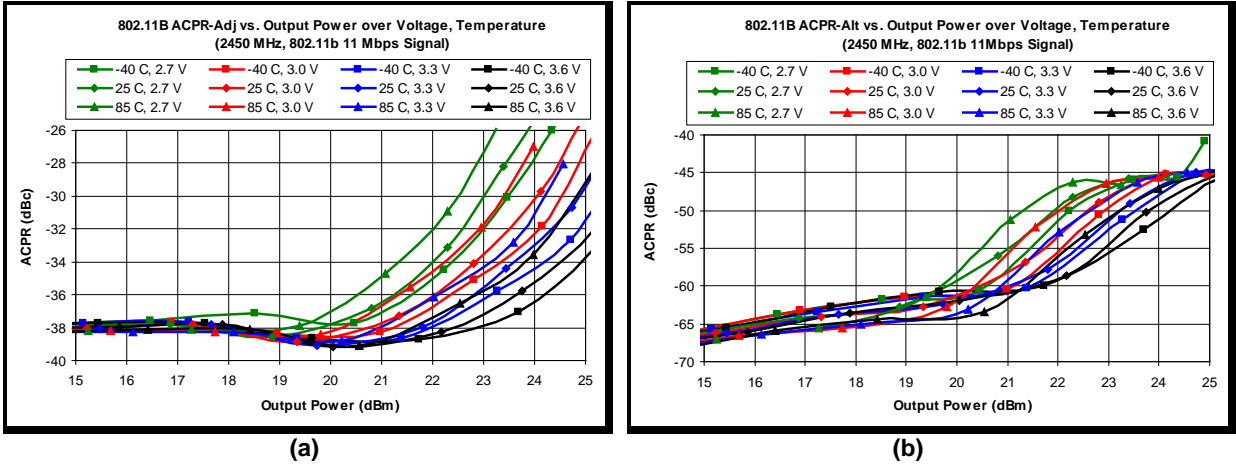

Figure 12: 802.11b Typical ACPR Performance over Voltage and Temperature (11 Mbps, CCK, BT = 0.45) (a) 802.11b ACPR-ADJ vs. POUT and (b) 802.11b ACPR-ALT vs. POUT

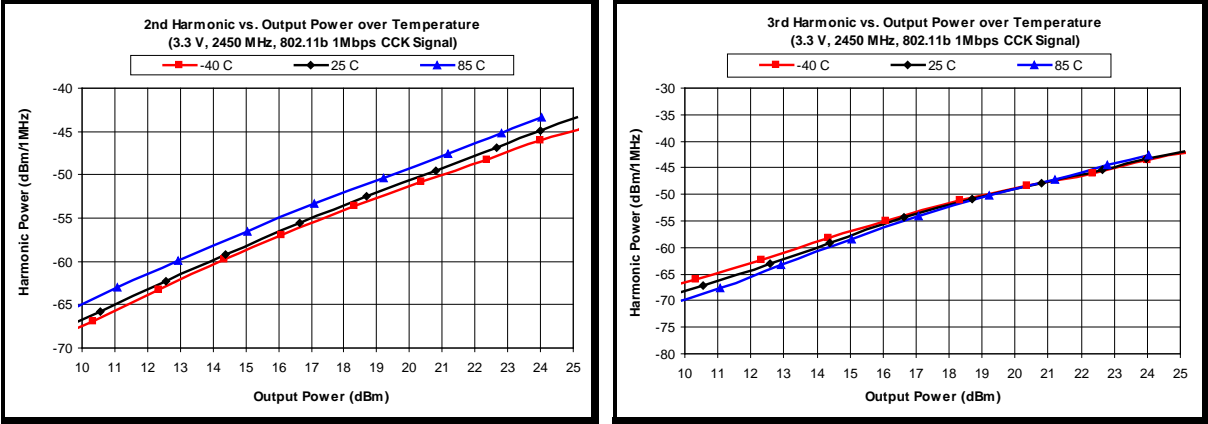

Figure 13: 802.11b Typical Harmonic Performance over Temperature (1 Mbps, CCK) (a) 2nd Harmonic (b) 3rd Harmonic

DATA SHEET
SE2521A60: 2.4 GHz Wireless LAN Front-End

CW Typical Performance

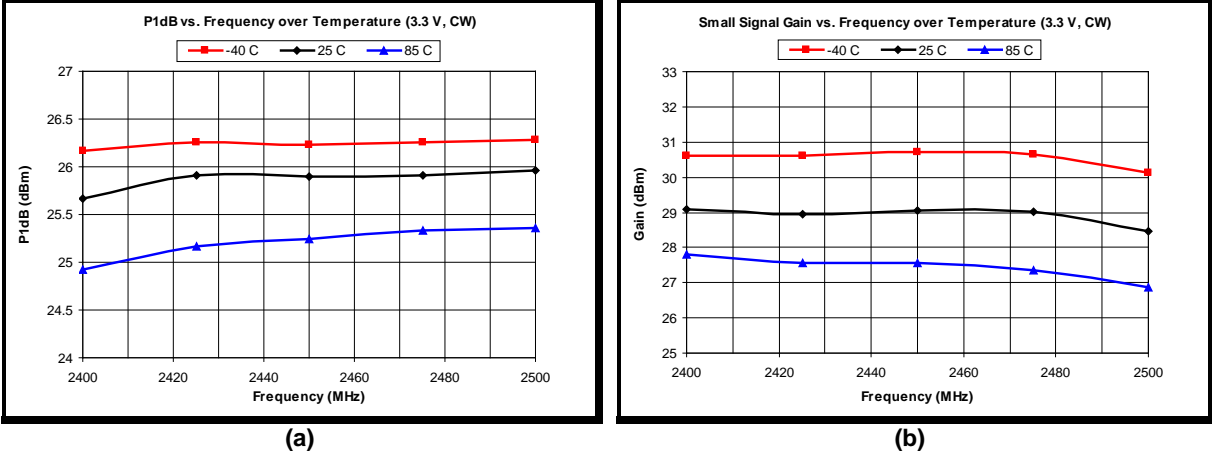

Figure 14: Typical CW Performance over Temperature (a) P1dB vs. Frequency, (b) Gain vs. Frequency

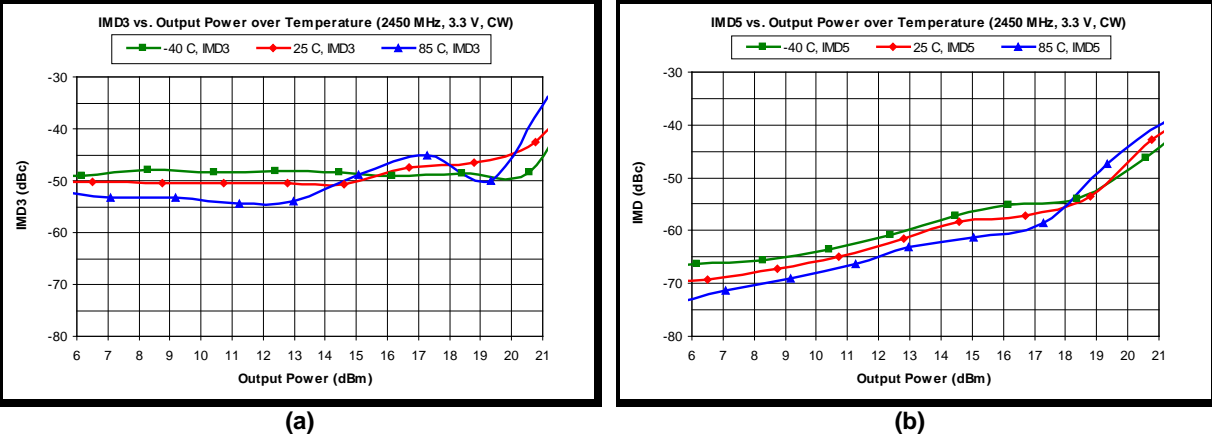

Figure 15: Typical CW Performance over Temperature (a) IMD3 vs. Output Power, (b) P1dB vs. Frequency

DATA SHEET

SE2521A60: 2.4 GHz Wireless LAN Front-End

Typical Power Detector Performance

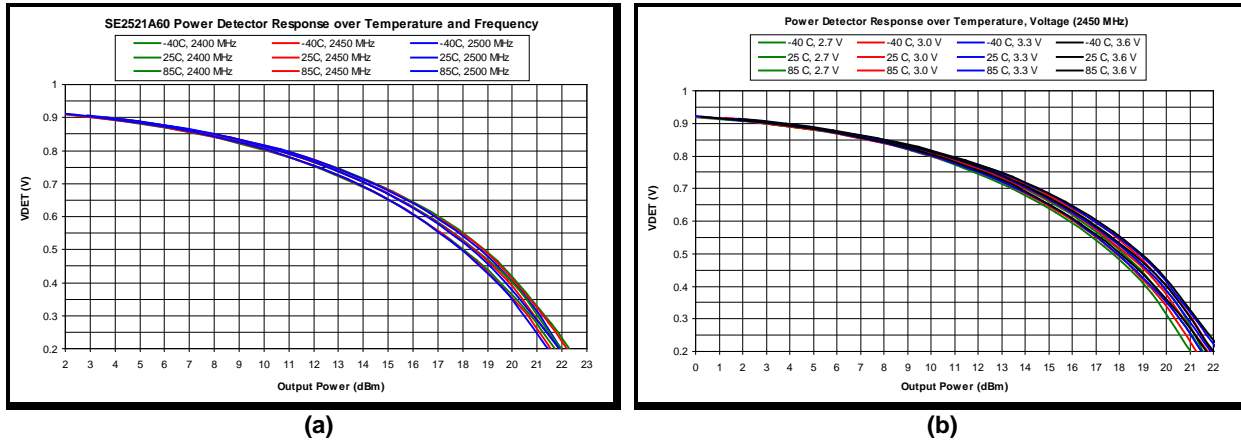

Figure 16: Typical Power Detector Response: (a) Over Frequency and Temperature, (b) Over Voltage and Temperature

Package Information

Figure 17 shows the detailed device package diagram. The pads on the Skyworks RF modules are plated with gold over nickel, with a gold thickness of approx. 0.75 to 1.0 um. The modules can be reflowed onto FR4 based material using eutectic Pb based or common tin based Pb free solder pastes.

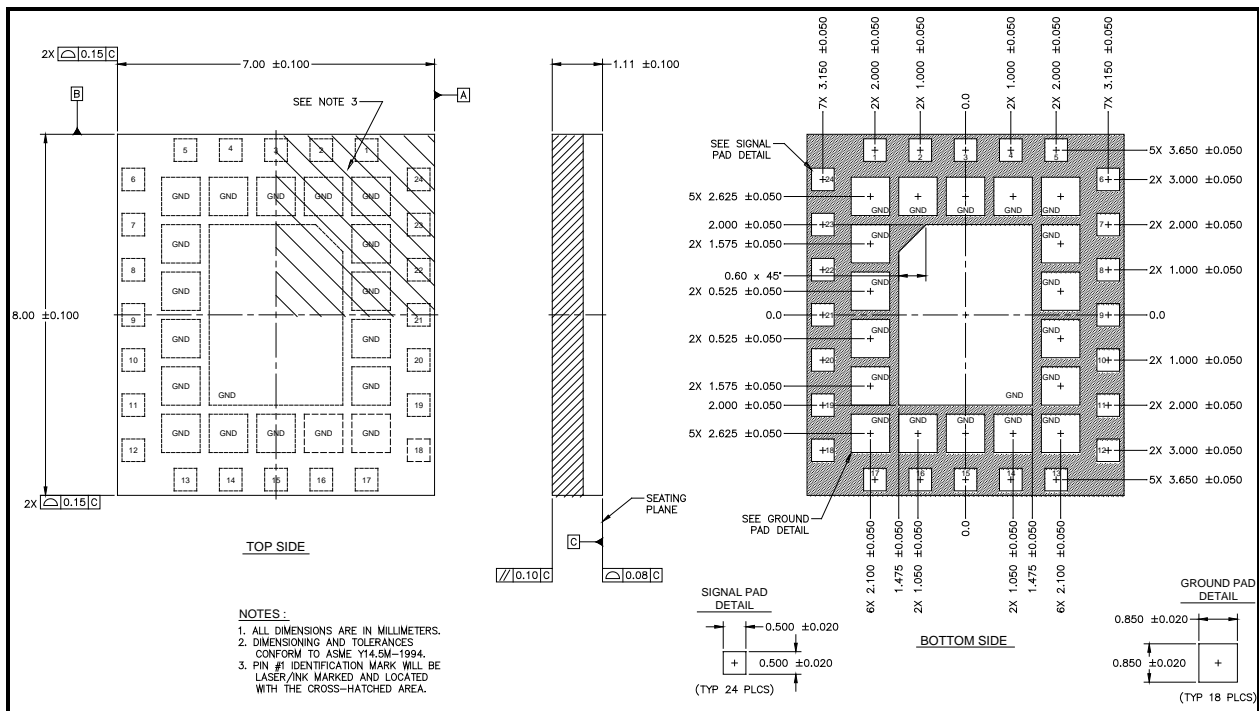

Figure 17: SE2521A60 Package Diagram

DATA SHEET

SE2521A60: 2.4 GHz Wireless LAN Front-End

Package Handling Information

Because of its sensitivity to moisture absorption, instructions on the shipping container label must be followed regarding exposure to moisture after the container seal is broken, otherwise, problems related to moisture absorption may occur when the part is subjected to high temperature during solder assembly. The SE2521A60 is capable of withstanding a Pb free solder reflow. Care must be taken when attaching this product, whether it is done manually or in a production solder reflow environment. If the part is manually attached, precaution should be taken to insure that the device is not subjected to temperatures above its rated peak temperature for an extended period of time. For details on both attachment techniques, precautions, and handling procedures recommended, please refer to:

- “Land Grid Array Module Solder Reflow & Rework Information”, *Document Number QAD-00046*
- “Handling, Packing, Shipping and Use of Moisture Sensitive LGA”, *Document Number QAD-00047*

Recommended PCB Footprint

Figure 18 shows the recommended PCB footprint for the SE2521A60.

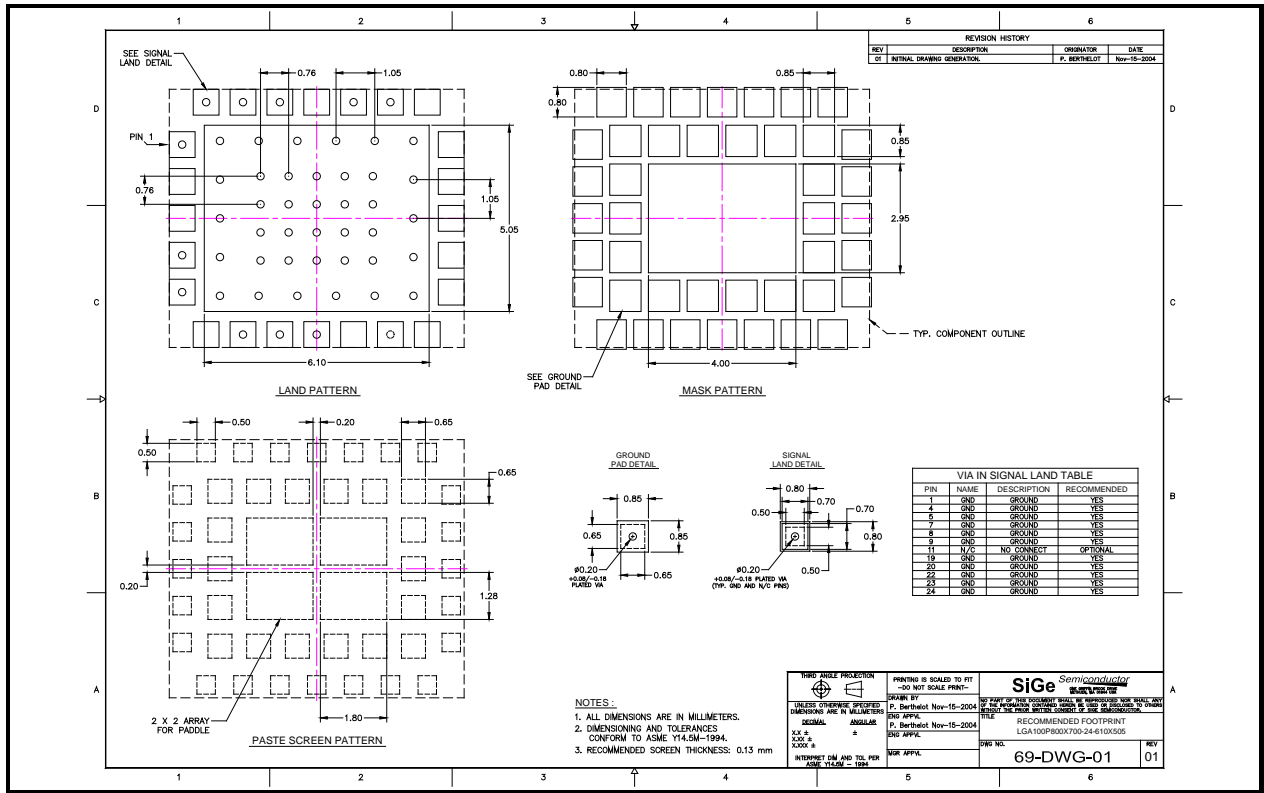

Figure 18: SE2521A60 Recommended PCB Footprint

DATA SHEET

SE2521A60: 2.4 GHz Wireless LAN Front-End

Branding Information

The device branding is shown in Figure 19.

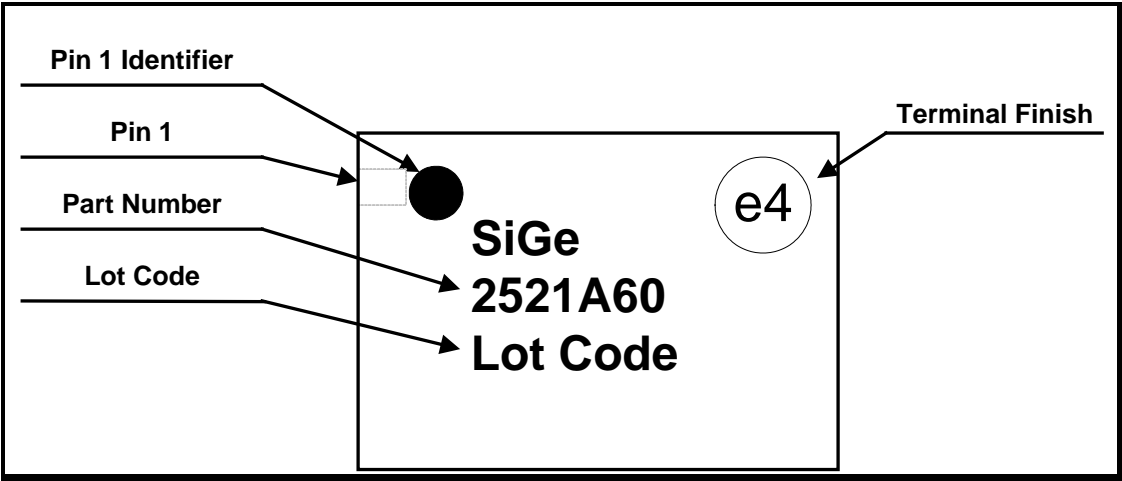
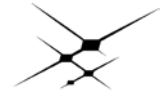

Figure 19: SE2521A60 Branding and Pin 1 Location

Tape and Reel

Production quantities of this product are shipped in a standard tape-and-reel format. Specific tape and reel dimensions and sizing is shown in Table 1 and Figure 20.

Parameter	Value
Devices Per Reel	2500
Reel Diameter	13 inches



SKYWORKS®

DATA SHEET

SE2521A60: 2.4 GHz Wireless LAN Front-End

Table 1: Tape and Reel

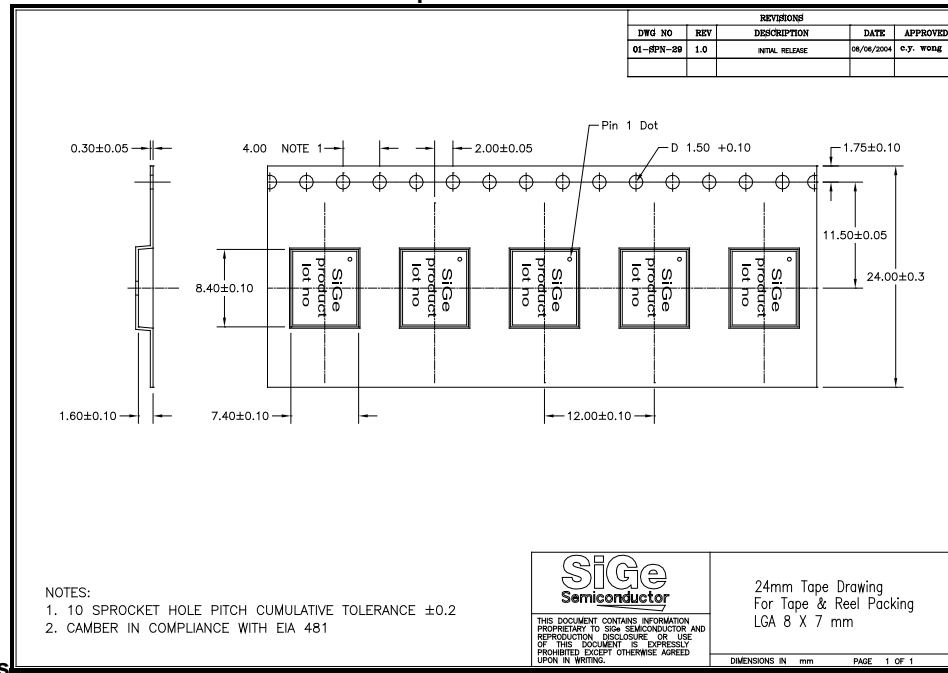

Dimensions

Figure 20: SE2521A60 Tape and Reel Information

Copyright © 2012 Skyworks Solutions, Inc. All Rights Reserved.

Information in this document is provided in connection with Skyworks Solutions, Inc. ("Skyworks") products or services. These materials, including the information contained herein, are provided by Skyworks as a service to its customers and may be used for informational purposes only by the customer. Skyworks assumes no responsibility for errors or omissions in these materials or the information contained herein. Skyworks may change its documentation, products, services, specifications or product descriptions at any time, without notice. Skyworks makes no commitment to update the materials or information and shall have no responsibility whatsoever for conflicts, incompatibilities, or other difficulties arising from any future changes.

No license, whether express, implied, by estoppel or otherwise, is granted to any intellectual property rights by this document. Skyworks assumes no liability for any materials, products or information provided hereunder, including the sale, distribution, reproduction or use of Skyworks products, information or materials, except as may be provided in Skyworks Terms and Conditions of Sale.

THE MATERIALS, PRODUCTS AND INFORMATION ARE PROVIDED "AS IS" WITHOUT WARRANTY OF ANY KIND, WHETHER EXPRESS, IMPLIED, STATUTORY, OR OTHERWISE, INCLUDING FITNESS FOR A PARTICULAR PURPOSE OR USE, MERCHANTABILITY, PERFORMANCE, QUALITY OR NON-INFRINGEMENT OF ANY INTELLECTUAL PROPERTY RIGHT; ALL SUCH WARRANTIES ARE HEREBY EXPRESSLY DISCLAIMED. SKYWORKS DOES NOT WARRANT THE ACCURACY OR COMPLETENESS OF THE INFORMATION, TEXT, GRAPHICS OR OTHER ITEMS CONTAINED WITHIN THESE MATERIALS. SKYWORKS SHALL NOT BE LIABLE FOR ANY DAMAGES, INCLUDING BUT NOT LIMITED TO ANY SPECIAL, INDIRECT, INCIDENTAL, STATUTORY, OR CONSEQUENTIAL DAMAGES, INCLUDING WITHOUT LIMITATION, LOST REVENUES OR LOST PROFITS THAT MAY RESULT FROM THE USE OF THE MATERIALS OR INFORMATION, WHETHER OR NOT THE RECIPIENT OF MATERIALS HAS BEEN ADVISED OF THE POSSIBILITY OF SUCH DAMAGE.

Skyworks products are not intended for use in medical, lifesaving or life-sustaining applications, or other equipment in which the failure of the Skyworks products could lead to personal injury, death, physical or environmental damage. Skyworks customers using or selling Skyworks products for use in such applications do so at their own risk and agree to fully indemnify Skyworks for any damages resulting from such improper use or sale.

Customers are responsible for their products and applications using Skyworks products, which may deviate from published specifications as a result of design defects, errors, or operation of products outside of published parameters or design specifications. Customers should include design and operating safeguards to minimize these and other risks. Skyworks assumes no liability for applications assistance, customer product design, or damage to any equipment resulting from the use of Skyworks products outside of stated published specifications or parameters.

Skyworks, the Skyworks symbol, and "Breakthrough Simplicity" are trademarks or registered trademarks of Skyworks Solutions, Inc., in the United States and other countries. Third-party brands and names are for identification purposes only, and are the property of their respective owners. Additional information, including relevant terms and conditions, posted at www.skyworksinc.com, are incorporated by reference.