

FEATURES

- High Linearity, High Output Power Integrated Amplifier with Programmable Gain Control
- Attenuation Range: 0-58 dB, Adjustable in 2 dB Increments via a 3-wire Serial Control
- 33 dB Gain (at Minimum Attenuation)
- Low Distortion Products at Output Power Levels up to +64 dBmV
- Low Noise Figure and Output Noise
- Frequency range: 5-85 MHz
- 5 V Operation
- Materials set consistent with RoHS Directives. Surface Mount Package

APPLICATIONS

- DOCSIS 3.0 Data Cable Modems and E-MTAs
- CATV Set Top Boxes

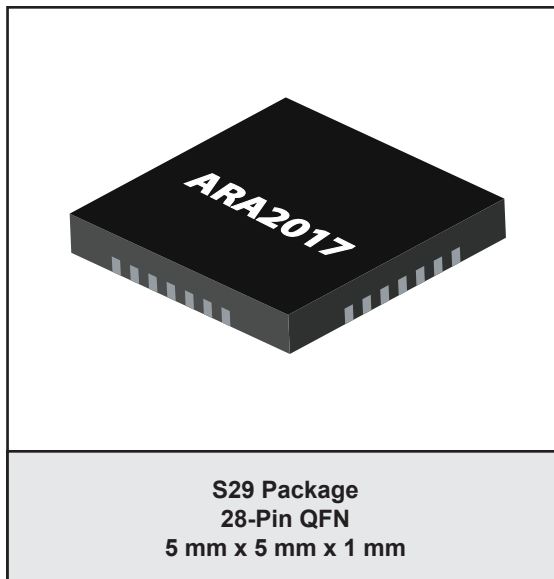

PRODUCT DESCRIPTION

The ARA2017 is a highly linear, high output power, programmable gain amplifier optimized for DOCSIS 3.0 cable modem and E-MTA applications. Using a low noise input amplification stage and an ultra linear output driver amplifier, the device generates extremely low distortion products at the high output power levels required by DOCSIS 3.0 signals. Its balanced circuit design provides superior harmonic performance and an integrated digitally-controlled, multiple-stage precision step attenuator enables system solutions to meet DOCSIS power step accuracy requirements.

The ARA2017 supports output power levels of +64 dBmV while minimizing harmonic, distortion, and output noise levels. Its precision attenuator provides up to 58 dB of attenuation in 2 dB increments, which is set by programming the register via a 3-wire serial interface. The output stage current, a feature which allows the device to be operated in reduced power modes for extended backup battery life, is also programmed through the 3-wire serial interface. The ARA2017 is offered in a 28-pin 5 mm x 5 mm x 1 mm QFN package.

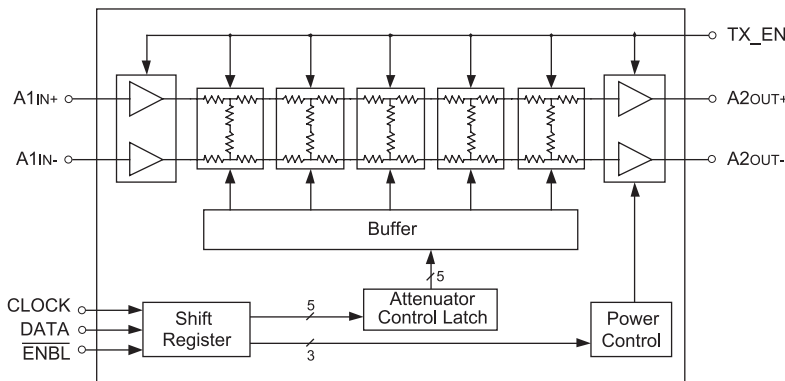

Figure 1: Functional Block Diagram

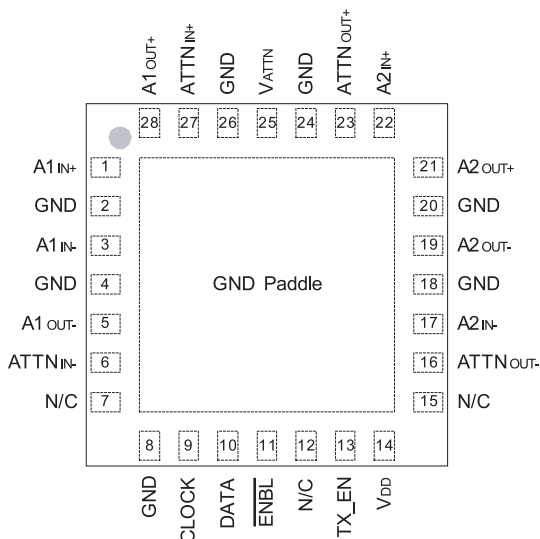

Figure 2: Pinout (X-Ray Top View)

Table 1: Pin Description

PIN	NAME	DESCRIPTION	PIN	NAME	DESCRIPTION
1	A1IN+	Amplifier A1 (+) Input	28	A1OUT+	Amplifier A1 (+) Output and Supply
2	GND	Ground	27	ATTNIN+	Attenuator Input (+)
3	A1IN-	Amplifier A1 (-) Input	26	GND	Ground
4	GND	Ground	25	VATTN	Attenuator Supply
5	A1OUT-	Amplifier A1 (-) Output and Supply	24	GND	Ground
6	ATTNIN-	Attenuator Input (-)	23	ATTNOUT+	Attenuator Output (+)
7	N/C	No Connection	22	A2IN+	Amplifier A2 (+) Input
8	GND	Ground	21	A2OUT+	Amplifier A2 (+) Output and Supply
9	CLOCK	Clock	20	GND	Ground
10	DATA	Data	19	A2OUT-	Amplifier A2 (-) Output and Supply
11	ENBL	Enable	18	GND	Ground
12	N/C	No Connection (Reserved for future use - leave floating)	17	A2IN-	Amplifier A2 (-) Input
13	TX_EN	Transmit Enable	16	ATTNOUT-	Attenuator Output (-)
14	VDD	Supply	15	N/C	No Connection

ELECTRICAL CHARACTERISTICS

Table 2: Absolute Minimum and Maximum Ratings

PARAMETER	MIN	MAX	UNIT	COMMENTS
Supply: V_{DD} (pins 5, 14, 19, 21, 28), V_{ATTN} (pin 25)	0	+6	V	
RF Power at Inputs (pins 1, 3)	-	+40	dBmV	differential into 200 Ω
Digital Interface (pins 9, 10, 11, 13)	-0.5	$V_{DD}+0.5$	V	
Storage Temperature	-55	+150	$^{\circ}\text{C}$	

Stresses in excess of the absolute ratings may cause permanent damage. Functional operation is not implied under these conditions. Exposure to absolute ratings for extended periods of time may adversely affect reliability.

Table 3: Operating Ranges

PARAMETER	MIN	TYP	MAX	UNIT
Operating Frequency (f)	5	-	85	MHz
Supply: V_{DD} (pins 5, 14, 19, 21, 28)	+4.5	+5	+5.5	V
Digital Interface (pins 9, 10, 11, 13)	0	-	V_{DD}	V
Case Temperature (T_c)	-40	+25	+95	$^{\circ}\text{C}$

The device may be operated safely over these conditions; however, parametric performance is guaranteed only over the conditions defined in the electrical specifications.

Table 4: Digital Interface Specifications
($V_{DD} = +5.0\text{ V}$)

PARAMETER	MIN	TYP	MAX	UNIT
Logic High Input Voltage: $V_{IN,HIGH}$	+2.0	-	V_{DD}	V
Logic Low Input Voltage: $V_{IN,LOW}$	0	-	+0.8	V

Note:

(1) Logic control levels apply to the 3-wire programming bus (pins 9, 10, 11) and the transmit enable control (pin 13).

Table 5: Electrical Specifications
 (V_{DD} = +5.0 V, Tx Enabled (unless otherwise noted), T_C = 25 °C)

PARAMETER	MIN	TYP	MAX	UNIT	COMMENTS
Gain ⁽¹⁾	34	36	37	dB	0 dB attenuation setting
Gain Flatness ⁽¹⁾	-	0.5 1.0	-	dB	5 to 42 MHz 5 to 85 MHz
Gain Variation over Temperature	-	-0.02	-	dB/°C	
Gain Range with Attenuator	58	-	-	dB	
Incremental Attenuator Step Size	1.5	2	2.5	dB	
2 nd Harmonic Distortion Level ^{(1) (2)}	-	-67	-55	dBc	+64 dBmV into 75 Ω
3 rd Harmonic Distortion Level ^{(1) (2)}	-	-72	-55	dBc	+64 dBmV into 75 Ω
3rd Order Output Intercept ^{(1) (2)}	+88	+93	-	dBmV	2 tone, +61 dBmV/tone
1 dB Gain Compression ^{(1) (2)}	-	+73	-	dBmV	
Noise Figure ^{(1) (2)}	-	2.5	4.5	dB	Full gain @ 0 dB attenuator setting; Includes input balun loss
Output Noise Power Active / No Signal / Min. Atten. Set. Active / No Signal / Max. Atten. Set.	- -	-38.5 -53.8	- -	dBmV	Any 160 kHz bandwidth from 5 to 85 MHz
Isolation (85 MHz) in Tx disable mode	-	60	-	dB	
Differential Input Impedance	-	200	-	Ω	between pins 1 and 3 (Tx enabled)
Differential Output Impedance	-	75	-	Ω	between pins 19 and 21
Output Impedance	-	75	-	Ω	with transformer
Output Return Loss (75 Ohm characteristic impedance)	- -	-15 -12	- -	dB	Tx enabled Tx disabled
Output Voltage Transient Tx enable / Tx disable	- -	50 7	- -	mVp-p	0 dB attenuator setting 24 dB attenuator setting
Total Supply Current ^{(1) (2)} (pins 5, 14, 19, 21, 25, 28)	- -	340 10.5	400 -	mA	Tx enabled (TX_EN high) Tx disabled (TX_EN low)
Total Power Consumption	- -	1.7 52.5	- -	W mW	Tx enabled (TX_EN high) Tx disabled (TX_EN low)
Thermal Resistance (θ _{JC})	-	30	-	°C/W	

Notes:

(1) As measured in test fixture.

(2) Measured using the maximum current setting-see Application Information section.

DATA PLOTS

Figure 3: Gain vs. Frequency over Voltage
(T_c = 25 °C)

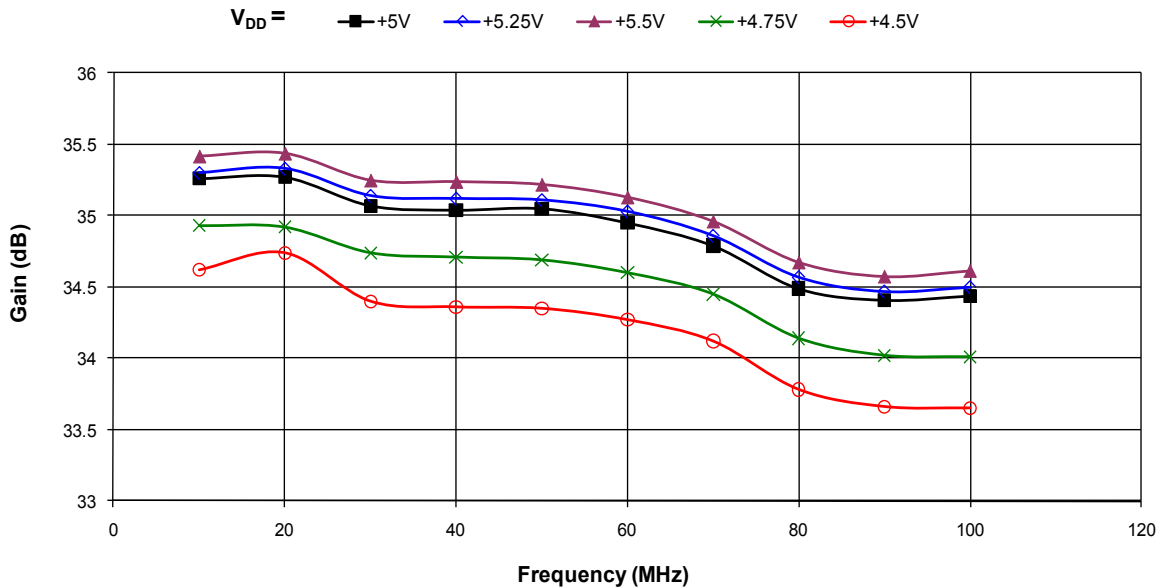

Figure 4: Noise Figure vs. Frequency over Voltage
(T_c = 25 °C)

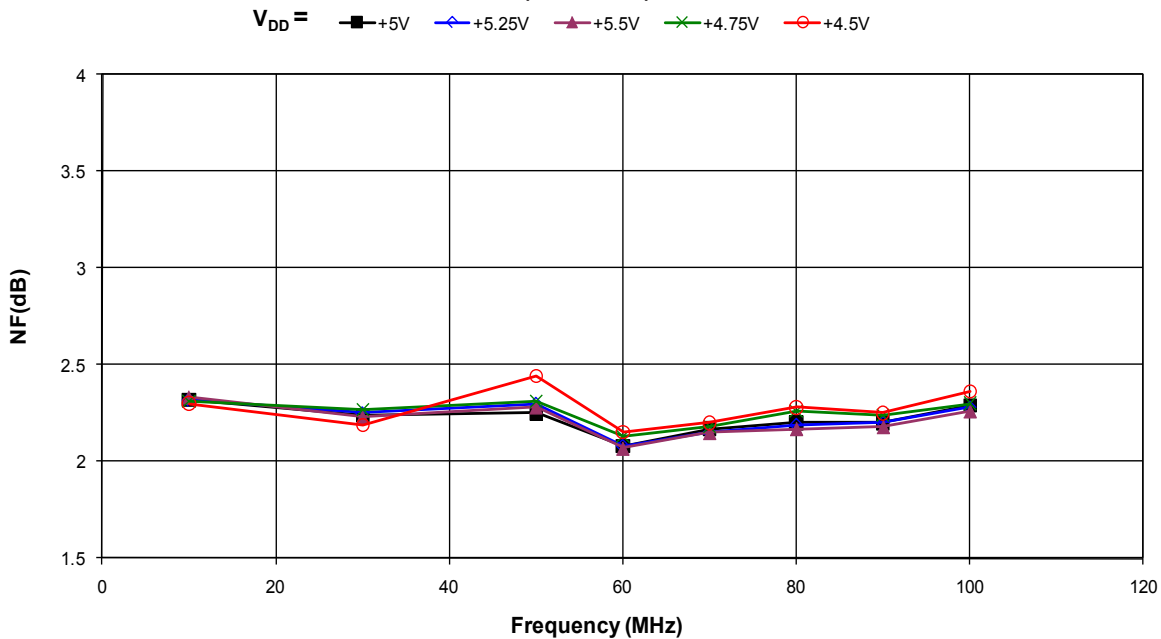

Figure 5: Gain & Noise Figure vs. Temperature
(Vdd = +5V, F1 = 10 MHz)

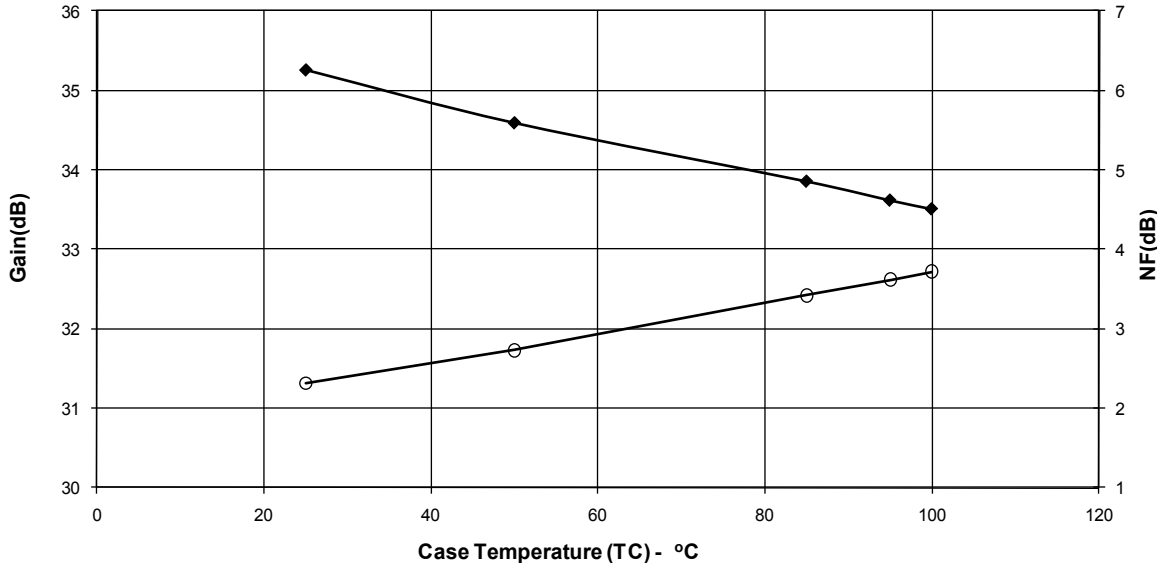

Figure 6: 1dB Gain Compression (P1dB) vs. Voltage
(Tc = 25 °C, F1 = 10 MHz)

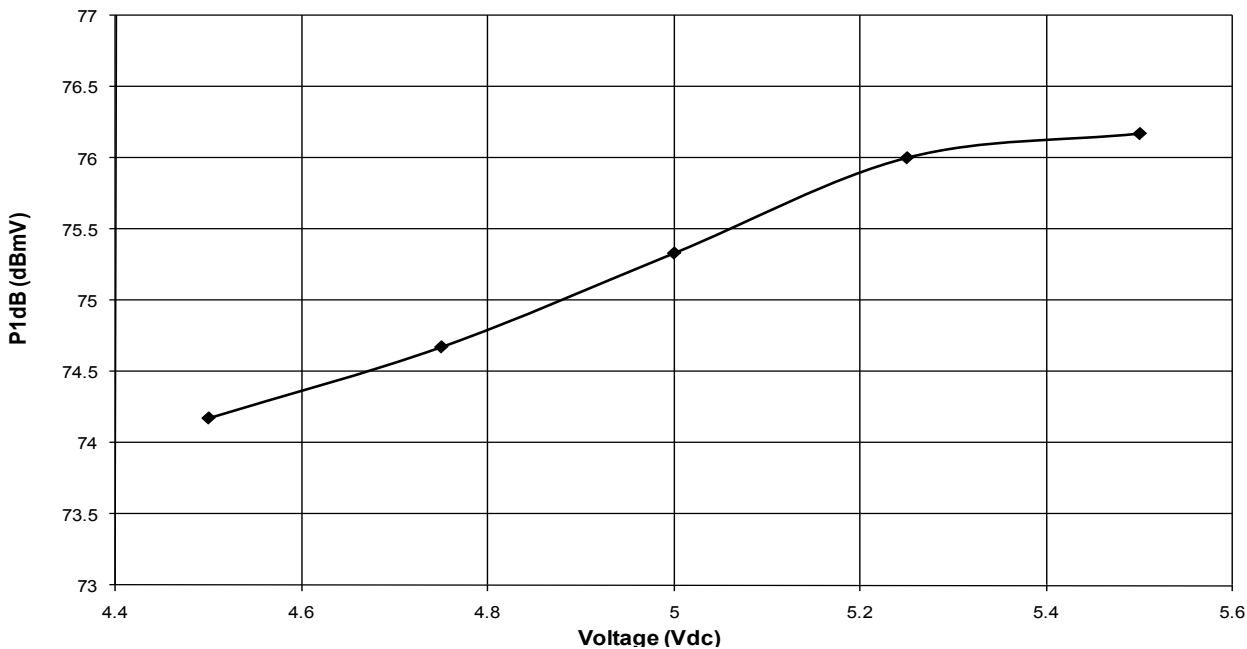

Figure 7: 1dB Gain Compression (P1dB) vs. Temperature
 (V_{DD} = +5 V, F₁ = 10 MHz)

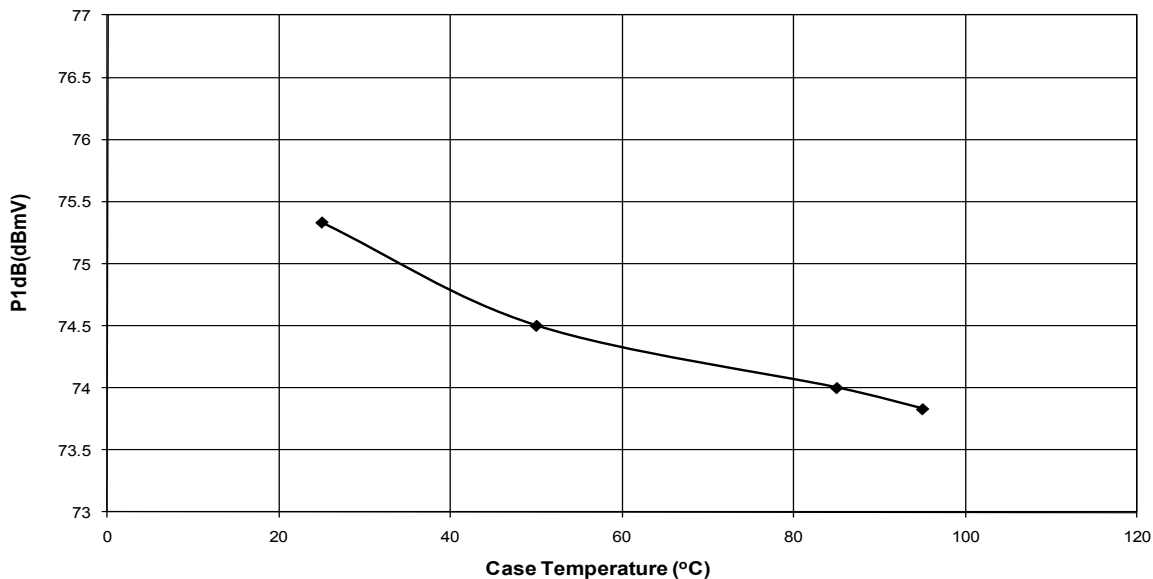

Figure 8: Output Third Order Intercept Point (OIP3) vs. Voltage
 (T_c = 25 °C, F₁ = 10 MHz, F₂ = 11 MHz)

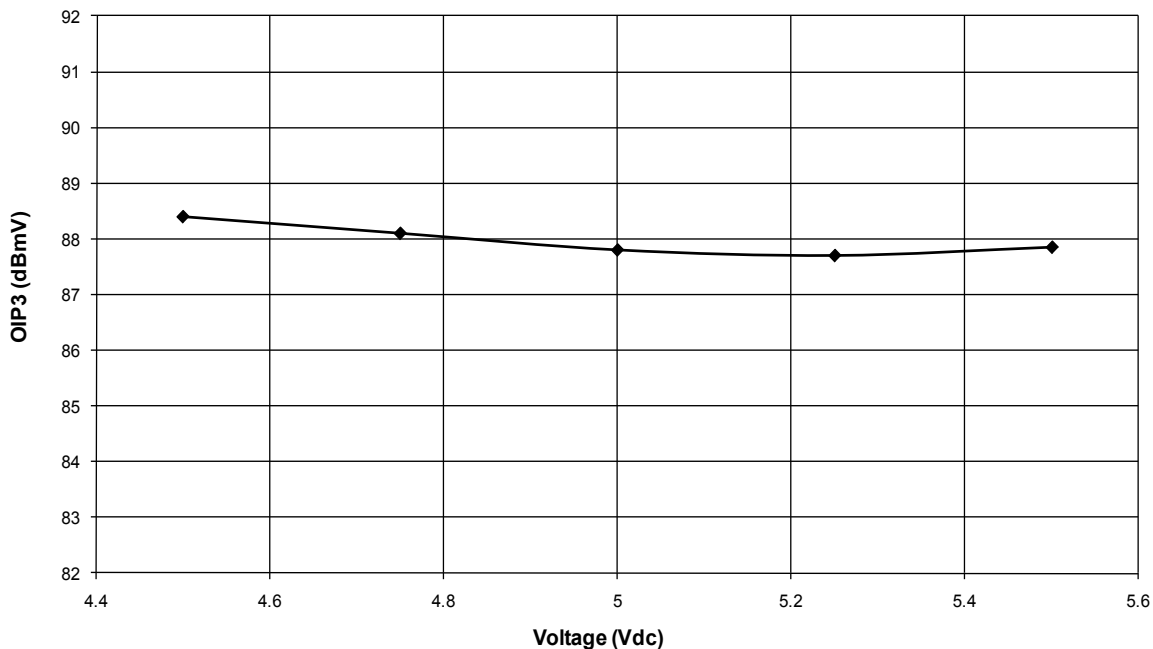

Figure 7: Output Third Order Intercept Point (OIP3) vs Temperature
 ($V_{DD} = +5 V_{DC}$, $F_1 = 10 \text{ MHz}$, $f_2 = 11 \text{ MHz}$)

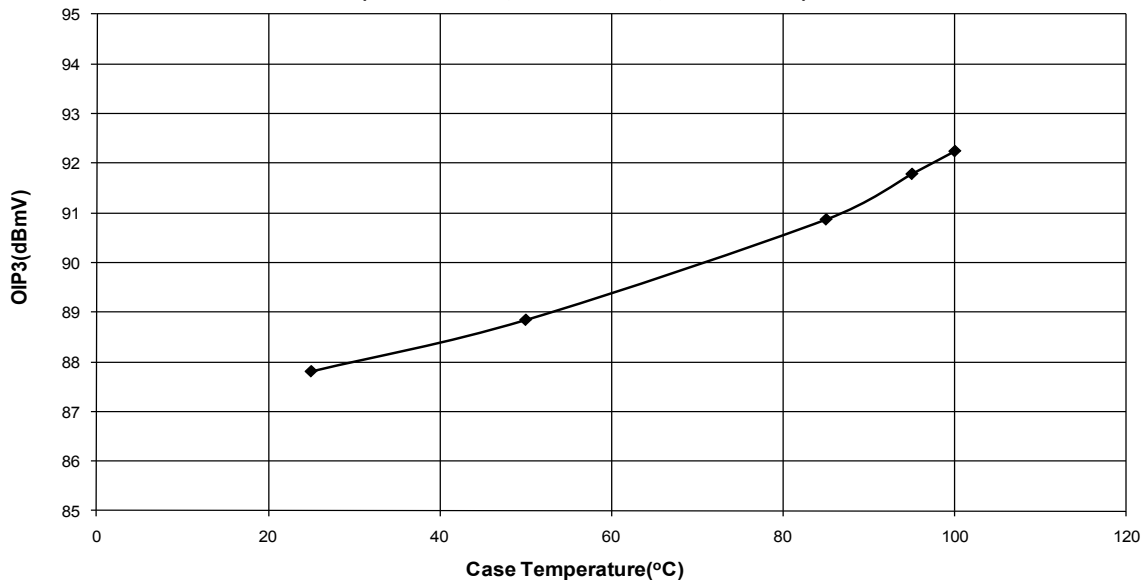

Figure 10: Attenuator Accuracy over Frequency
 ($T_C = 25 \text{ °C}$, $V_{DC} = +5V$)

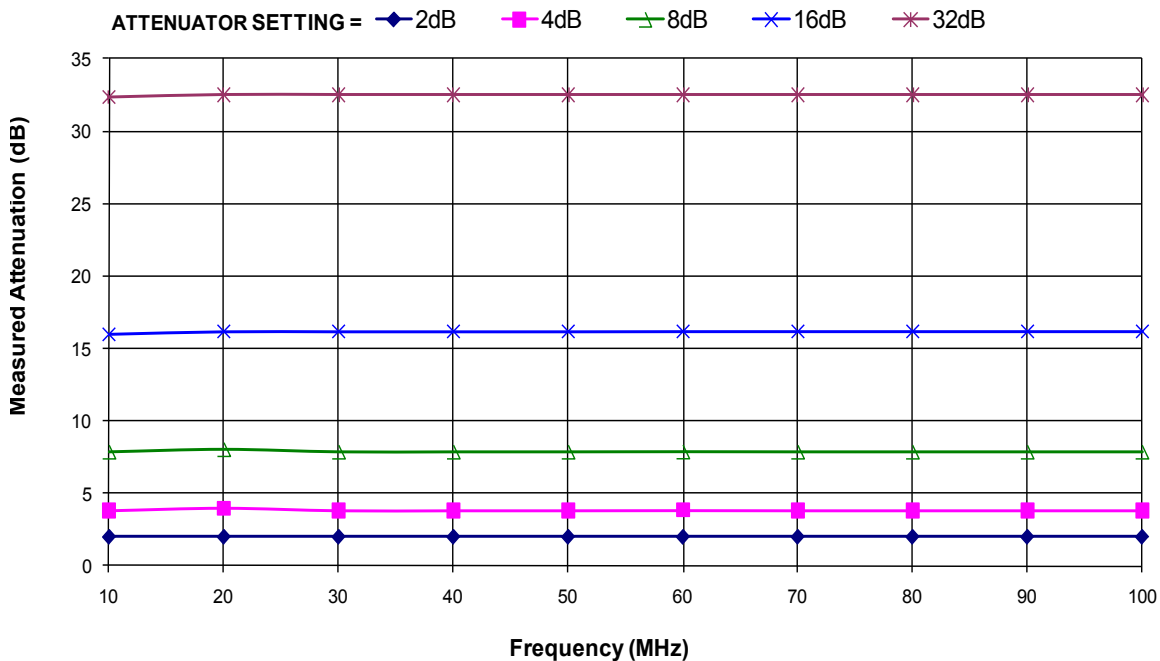

Figure 11: Attenuator Accuracy over Voltage
($T_c = +25\text{ }^\circ\text{C}$, $F_1 = 10\text{ MHz}$)

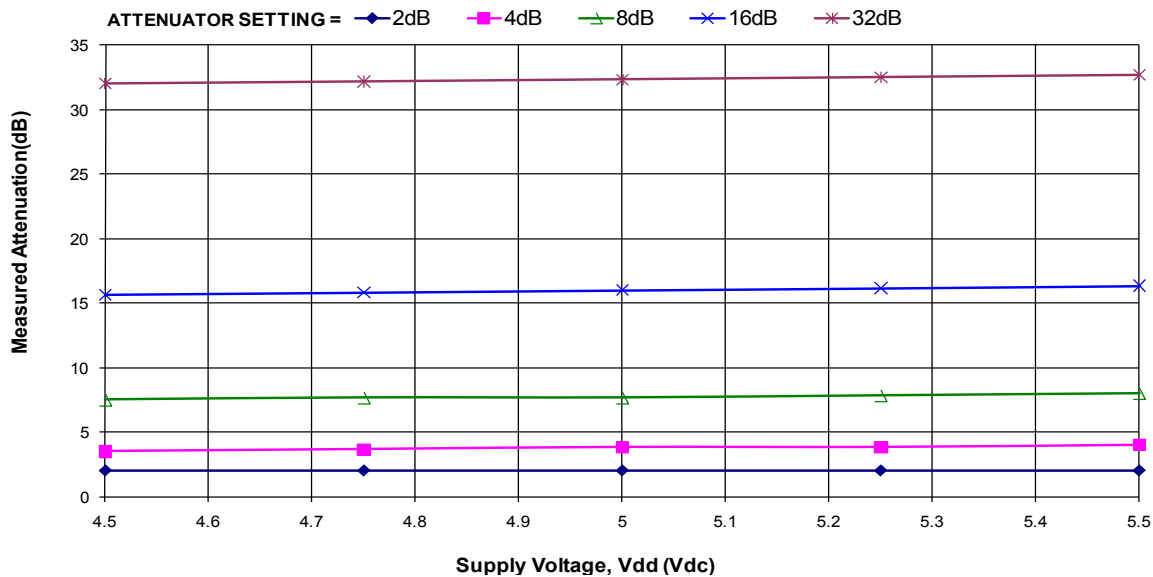

Figure 12: Attenuator Accuracy over Temperature
($V_{DC} = +5V$, $F_1 = 10\text{ MHz}$)

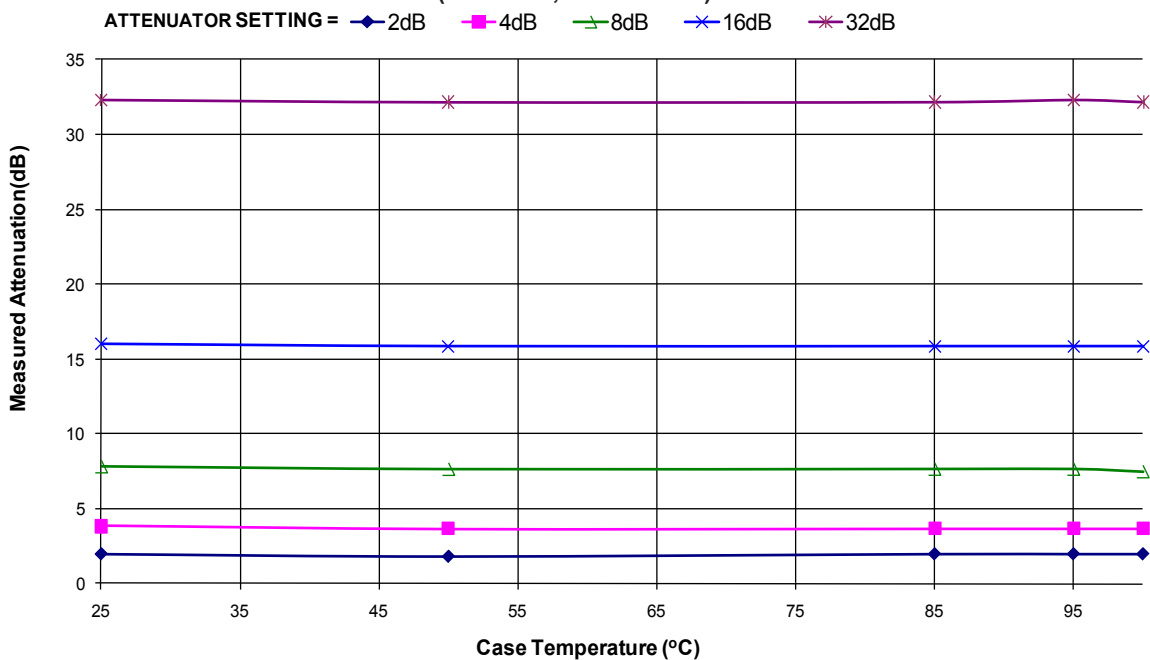

Figure 13: Gain & I_{dd} vs. Power Control Setting

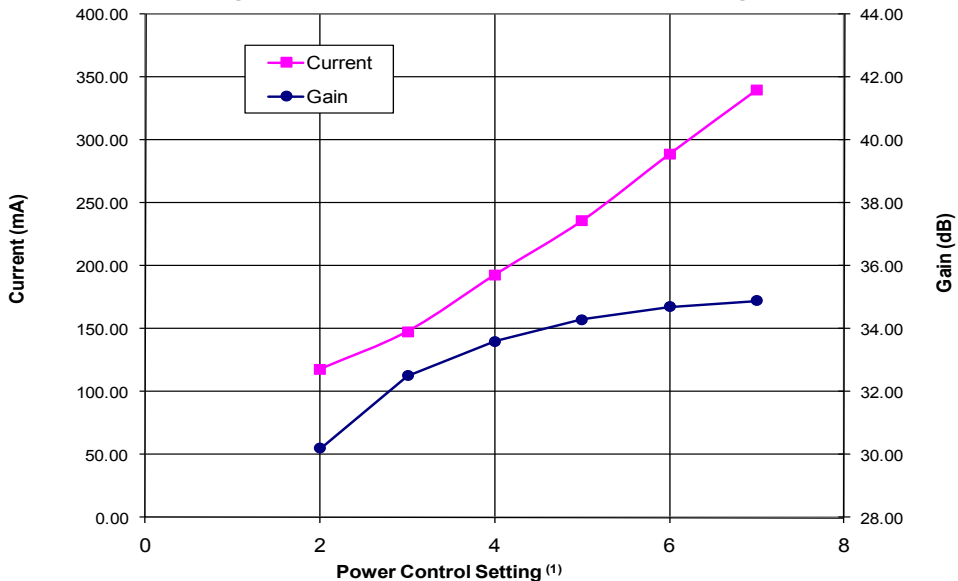

Figure 14: P_{out} & Harmonics vs. Power Control Setting

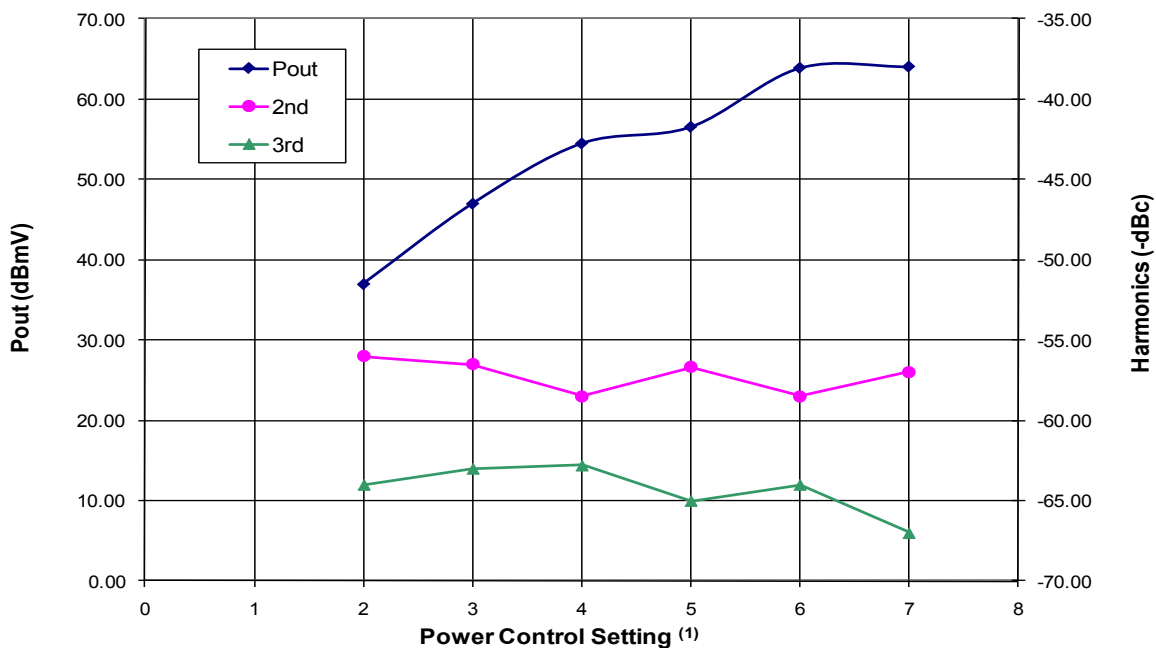

Figure 15: P1dB vs. Power Control Setting

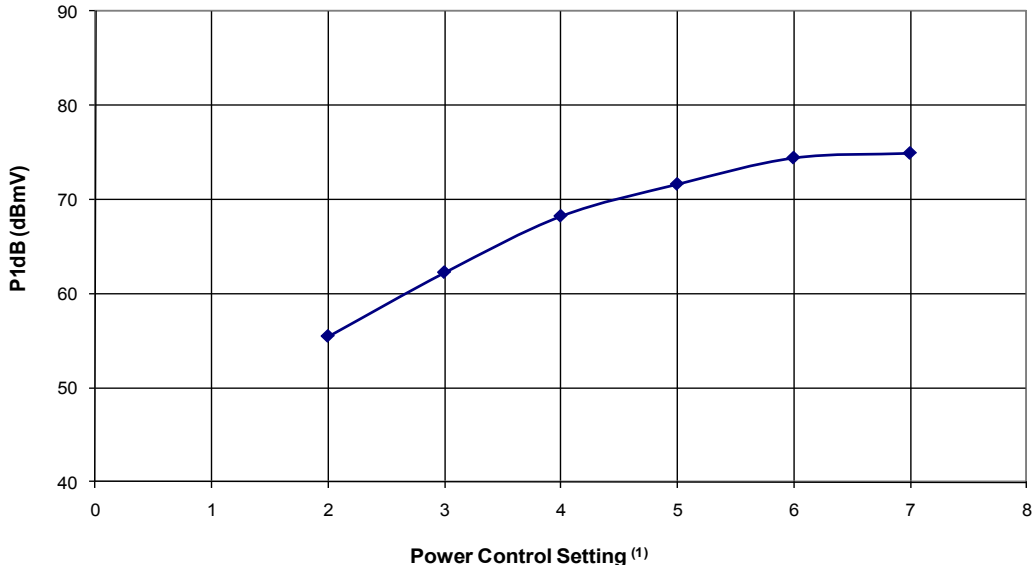
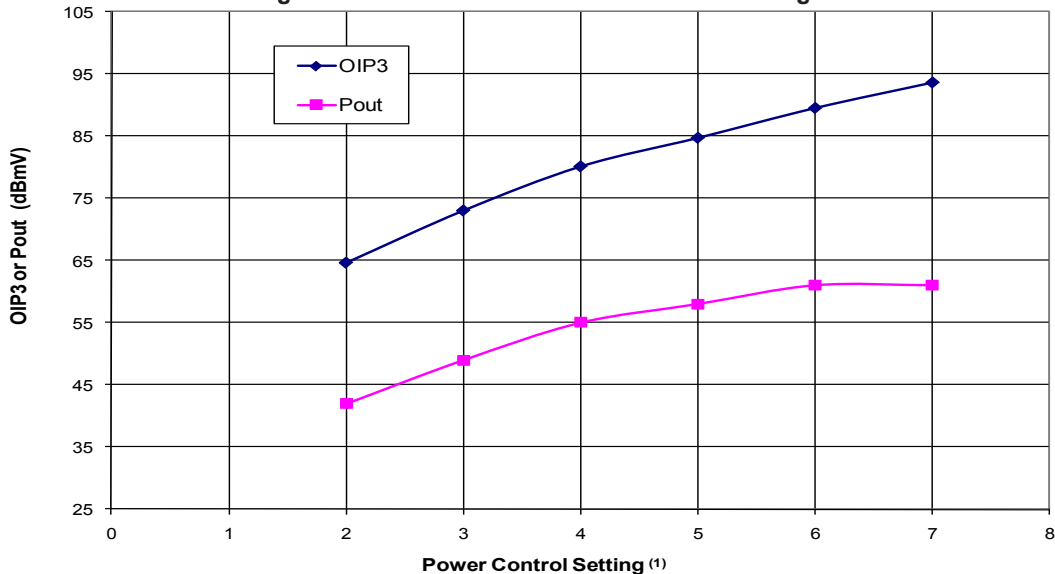
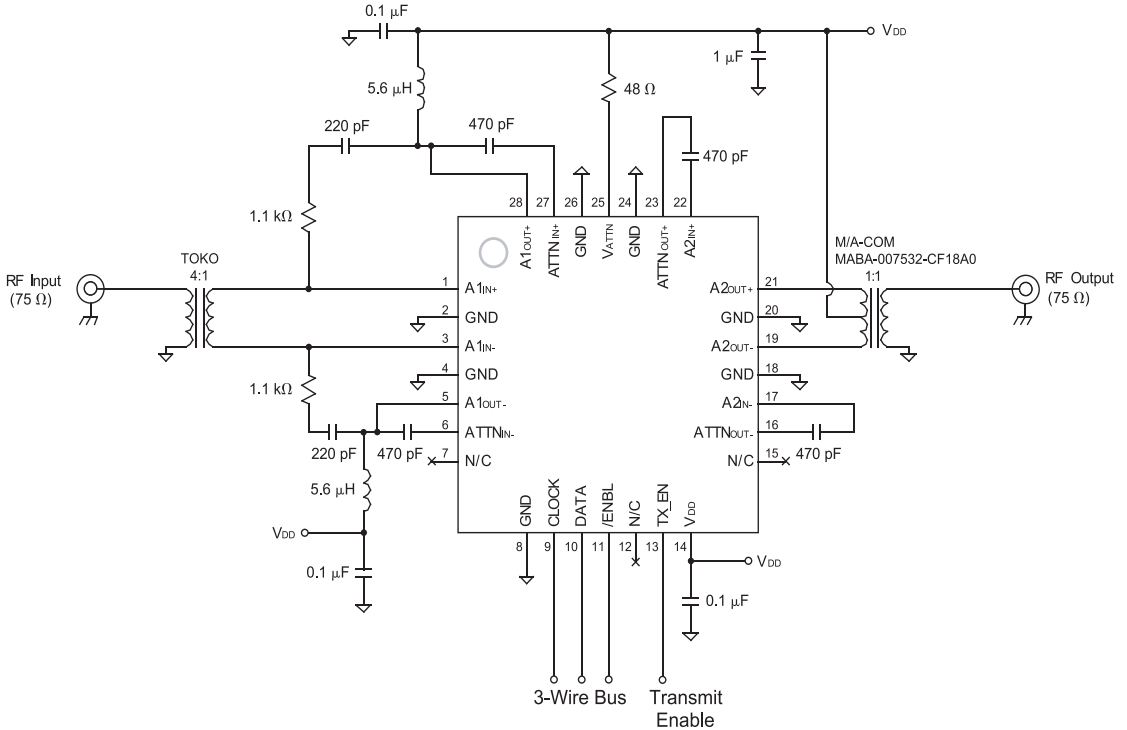

Figure 16: OIP3 & POUT vs. Power Control Setting



Notes (Figures 13-16):

(1) Power control setting refers to the programming register bits 7, 8, and 9 (see Table 6). The power control can be set using Tuner Control Software, version 1.2.3, in the “Advanced settings” window. The software is used in conjunction with the ARA2017 evaluation board.



Note: Pin 12 is reserved for future use. Do not connect (leave floating).

Figure 17: Test Circuit

Notes:

- (1) Pin 12 is reserved for future use. Do not connect (leave floating).
- (2) Input balun is used for evaluation test purposes only in 75 Ω system. Actual application does not require a 4:1 balun on the input.

LOGIC PROGRAMMING

Programming Instructions

The programming word is set through a 10 bit shift register via the data, clock and enable lines. The data is entered in order with the most significant bit (MSB) first and the least significant bit (LSB) last. The

enable line must be low for the duration of the data entry, then set high to latch the shift register. The rising edge of the clock pulse shifts each data value into the register.

Table 6: Programming Register

DATA BIT	9	8	7	6	5	4	3	2	1	0	
FUNCTION	Current			Gain						0	1

Notes:

- (1) Refer to Application Information section for Current and Gain bit settings.
- (2) Data bit 0 should always be set to "1".
- (3) Data bit 1 is reserved for future use, and should be set to "0".

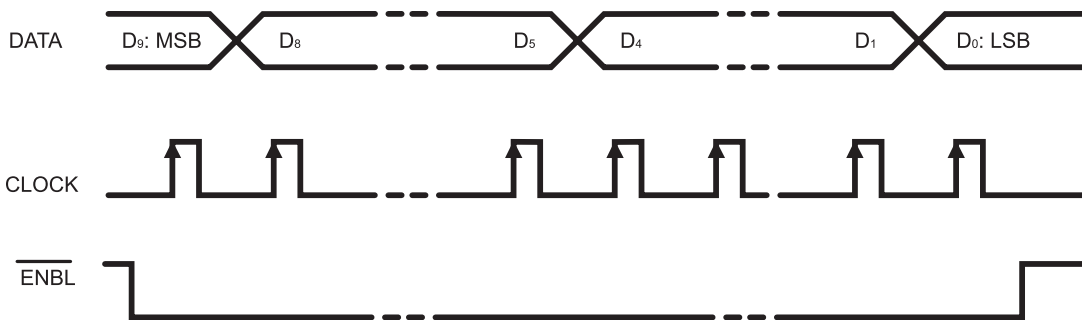

Figure 18: Serial Data Input Timing

APPLICATION INFORMATION

Transmit Enable / Disable

The ARA2017 can be switched on (Tx enable) and off (Tx disable) via an asynchronous input TX_EN (pin 13). A logic high will turn the amplifier on. The gain and current settings are retained during Tx disable and do not need to be reloaded.

Gain/Attenuator Setting

The gain of the ARA2017 can be controlled via the 3-wire bus. Data bits D2 through D6 set the gain/attenuator level, with 00000 being the min gain setting, and 11111 being the max gain setting. A new gain/attenuator setting can be loaded while the PGA is on (Tx enable), but will not take effect until TX_EN has been cycled off /on.

Output Stage Current Setting

The ARA2017 consists of 2 gain stages. The input stage operates at a constant fixed current when Tx is enabled. The current in the output stage can be controlled via the 3-wire bus. Data bits D7 – D9 set the current. 111 will set the output stage to maximum current for maximum linearity. The current can be lowered for improved efficiency at lower output power levels, or lower linearity requirements. 000 will turn both stages off, the same as Tx disable. A new current setting can be loaded while the PGA is on (Tx Enable), but will not take effect until TX_EN has been cycled off /on.

Output Transformer

Matching the balanced output of the ARA2017 to a single-ended 75 Ω load is accomplished using a 1:1 turns ratio transformer. In addition to the balanced to single-ended conversion, this transformer provides the bias to the output amplifier stage via the center tap.

The transformer also cancels even mode distortion products and common mode signals, such as the voltage transients that occur while enabling and disabling the amplifiers. As a result, care must be taken when selecting the transformer to be used at the output. It must be capable of handling the RF and DC power requirements without saturating the core, and it must have adequate isolation and good phase and amplitude balance. It also must operate over the desired frequency and temperature range for the intended application.

PACKAGE OUTLINE

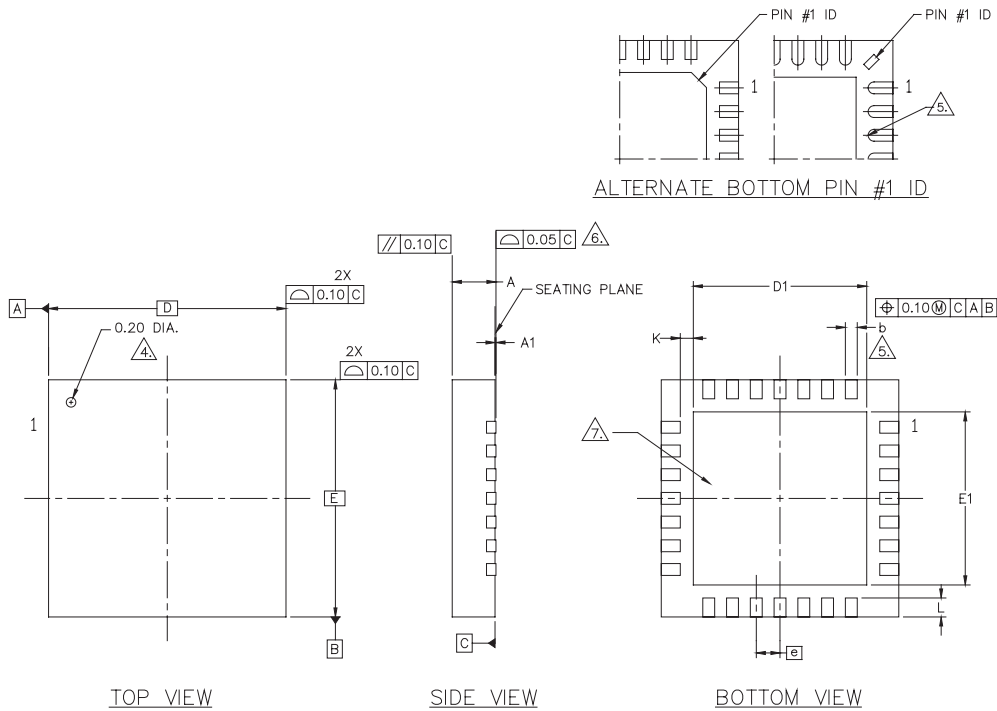

NOTES :

1. ALL DIMENSIONS ARE IN MILLIMETERS.
 2. MAX. PACKAGE WARPAGE IS 0.05 mm.
 3. MAXIMUM ALLOWABLE BURRS IS 0.076 mm IN ALL DIRECTIONS.
- ⚠ PIN #1 ID ON TOP WILL BE LASER MARKED.
- ⚠ DIMENSION b APPLIES TO METALLIZED TERMINAL AND IS MEASURED BETWEEN 0.25 AND 0.30mm FROM TERMINAL TIP. RADIUS OPTIONAL. DIMENSION b SHOULD NOT BE MEASURED IN RADIUS AREA.
- ⚠ BILATERAL COPLANARITY ZONE APPLIES TO THE EXPOSED HEAT SINK SLUG AS WELL AS THE TERMINALS.
7. REFERENCE JEDEC OUTLINE MO-220.

S W G	DIMENSIONS—MM		N O T E	S W G	DIMENSIONS—INCHES		N O T E
	MIN.	MAX.			MIN.	MAX.	
A	0.80	1.00		A	0.031	0.039	
A1	0.00	0.05		A1	0.000	0.002	
b	0.18	0.30		b	0.007	0.012	
D	5.00 BSC			D	0.197 BSC		
D1	3.40	3.80		D1	0.134	0.149	
E	5.00 BSC			E	0.197 BSC		
E1	3.40	3.80		E1	0.134	0.149	
Ⓜ	0.50 BSC			Ⓜ	0.020 BSC		
K	0.20 MIN.			K	0.007 MIN.		
L	0.35	0.57		L	0.014	0.022	

Figure 19: S29 Package Outline - 28 Pin 5 mm x 5 mm x 1 mm QFN

TOP BRAND

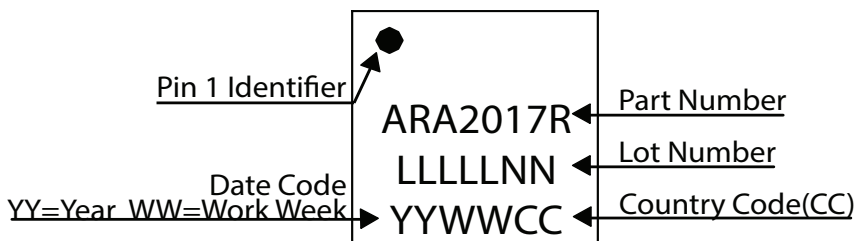
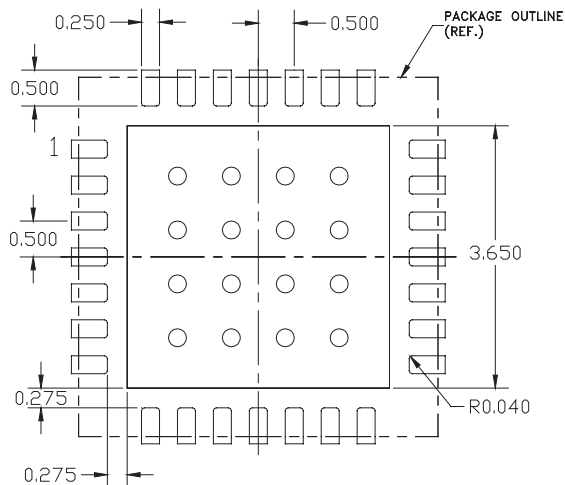

Figure 20: Branding Specification



NOTES:

- (1) UNLESS SPECIFIED DIMENSIONS ARE SYMMETRICAL ABOUT CENTER LINES SHOWN.
- (2) DIMENSIONS IN MILLIMETERS.
- (3) NUMBER OF THERMAL VIAS REQUIRED FOR EFFICIENT HEAT REMOVAL DEPENDENT ON THE PCB PROCESS CAPABILITY. VIAS SHOWN FOR REFERENCE ONLY

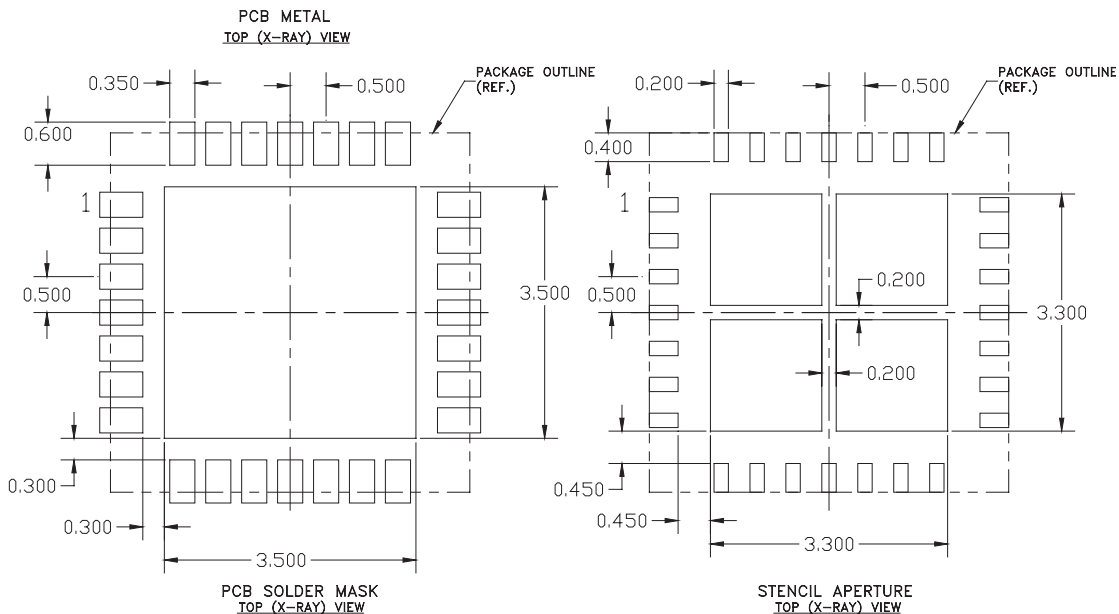

Figure 21: Land Pattern

ORDERING INFORMATION

ORDER NUMBER	TEMPERATURE RANGE	PACKAGE DESCRIPTION	COMPONENT PACKAGING
ARA2017RS29P8	-40 °C to +95 °C	28 Pin QFN Package 5 mm x 5 mm x 1 mm	Tape and Reel, 2500 pieces per Reel

Copyright © 2016 Skyworks Solutions, Inc. All Rights Reserved.

Information in this document is provided in connection with Skyworks Solutions, Inc. ("Skyworks") products or services. These materials, including the information contained herein, are provided by Skyworks as a service to its customers and may be used for informational purposes only by the customer. Skyworks assumes no responsibility for errors or omissions in these materials or the information contained herein. Skyworks may change its documentation, products, services, specifications or product descriptions at any time, without notice. Skyworks makes no commitment to update the materials or information and shall have no responsibility whatsoever for conflicts, incompatibilities, or other difficulties arising from any future changes.

No license, whether express, implied, by estoppel or otherwise, is granted to any intellectual property rights by this document. Skyworks assumes no liability for any materials, products or information provided hereunder, including the sale, distribution, reproduction or use of Skyworks products, information or materials, except as may be provided in Skyworks Terms and Conditions of Sale.

THE MATERIALS, PRODUCTS AND INFORMATION ARE PROVIDED "AS IS" WITHOUT WARRANTY OF ANY KIND, WHETHER EXPRESS, IMPLIED, STATUTORY, OR OTHERWISE, INCLUDING FITNESS FOR A PARTICULAR PURPOSE OR USE, MERCHANTABILITY, PERFORMANCE, QUALITY OR NON-INFRINGEMENT OF ANY INTELLECTUAL PROPERTY RIGHT; ALL SUCH WARRANTIES ARE HEREBY EXPRESSLY DISCLAIMED. SKYWORKS DOES NOT WARRANT THE ACCURACY OR COMPLETENESS OF THE INFORMATION, TEXT, GRAPHICS OR OTHER ITEMS CONTAINED WITHIN THESE MATERIALS. SKYWORKS SHALL NOT BE LIABLE FOR ANY DAMAGES, INCLUDING BUT NOT LIMITED TO ANY SPECIAL, INDIRECT, INCIDENTAL, STATUTORY, OR CONSEQUENTIAL DAMAGES, INCLUDING WITHOUT LIMITATION, LOST REVENUES OR LOST PROFITS THAT MAY RESULT FROM THE USE OF THE MATERIALS OR INFORMATION, WHETHER OR NOT THE RECIPIENT OF MATERIALS HAS BEEN ADVISED OF THE POSSIBILITY OF SUCH DAMAGE.

Skyworks products are not intended for use in medical, lifesaving or life-sustaining applications, or other equipment in which the failure of the Skyworks products could lead to personal injury, death, physical or environmental damage. Skyworks customers using or selling Skyworks products for use in such applications do so at their own risk and agree to fully indemnify Skyworks for any damages resulting from such improper use or sale.

Customers are responsible for their products and applications using Skyworks products, which may deviate from published specifications as a result of design defects, errors, or operation of products outside of published parameters or design specifications.

Customers should include design and operating safeguards to minimize these and other risks. Skyworks assumes no liability for applications assistance, customer product design, or damage to any equipment resulting from the use of Skyworks products outside of stated published specifications or parameters.

Skyworks and the Skyworks symbol are trademarks or registered trademarks of Skyworks Solutions, Inc., in the United States and other countries. Third-party brands and names are for identification purposes only, and are the property of their respective owners. Additional information, including relevant terms and conditions, posted at www.skyworksinc.com, are incorporated by reference.

Skyworks Solutions, Inc.

Phone [781] 376-3000 • Fax [781] 376-3100 • sales@skyworksinc.com • www.skyworksinc.com

Skyworks Proprietary and Confidential information • Products and Product Information are Subject to Change Without Notice