

DATA SHEET

SKYFR-001746: 3400 to 3800 MHz Single-Junction Robust Lead Circulator

Applications

- Wireless infrastructure
- Power amplifiers

Features

- Small surface-mount package
- Operating frequency range: 3400 MHz to 3800 MHz
- BeO free
- RoHS compliant
- Parts delivered on tape and reel



Skyworks Green™ products are compliant with all applicable legislation and are halogen-free. For additional information, refer to *Skyworks Definition of Green™*, document number SQ04-0074.

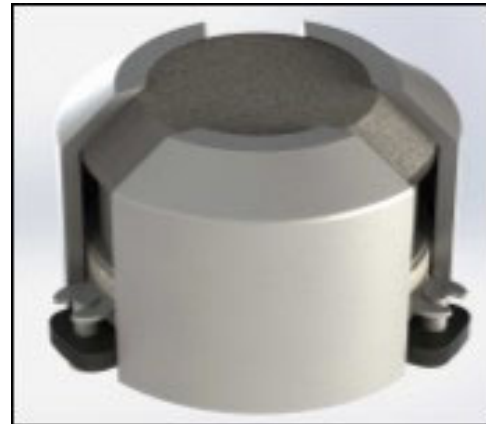

Description

The SKYFR-001746 is a single-junction, surface-mount circulator designed for wireless infrastructure and power-amplifier applications. It operates over the frequency range of 3400 MHz to 3800 MHz with an operating temperature range of -40 °C to +110 °C.

The SKYFR-001746 comes in an industry-standard surface-mount package and is designed for automated SMT placement.

A block diagram of the SKYFR-001746 is shown in Figure 1.

For tape and reel information, refer to the *Tape and Reel Guidelines for Isolators and Circulators* Application Note.

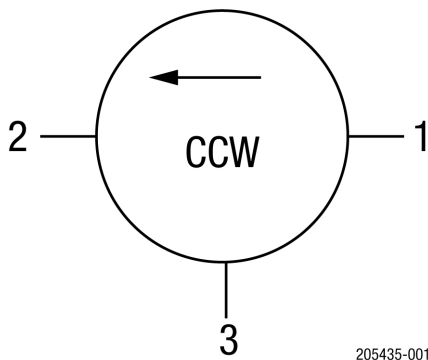

Figure 1. SKYFR-001746 Block Diagram

Electrical and Mechanical Specifications

The absolute maximum ratings of the SKYFR-001746 are provided in Table 1. Electrical specifications are provided in Table 2.

Plating information is shown in Table 3. Figure 2 shows the package dimensions and PCB footprint information.

Table 1. SKYFR-001746 Absolute Maximum Ratings¹

Parameter	Symbol	Minimum	Maximum	Units
Average power	P _{AVG}		20	W
Peak power	P _{PK}		160	W
Operating temperature ²	T _{OP}	-40	+110	°C
Storage temperature	T _{STOR}	-65	+155	°C

¹ Exposure to maximum rating conditions for extended periods may reduce device reliability. There is no damage to device with only one parameter set at the limit and all other parameters set at or below their nominal value. Exceeding any of the limits listed here may result in permanent damage to the device.

² The power rating and reliability of the device will not degrade with an operating temperature of up to +130°C. Exceeding any of the other limits listed here may result in permanent damage to the device or may reduce device reliability.

Table 2. SKYFR-001746 Electrical Specifications¹

Parameter	Symbol	Test Condition	Min	Typ	Max	Units
Frequency range	f		3400		3800	MHz
Impedance				50		Ω
Input impedance, real		@ 3400 MHz	48	51	54	Ω
Input impedance, imaginary		@ 3400 MHz	-6	-3	0	jΩ
Input impedance, real		@ 3600 MHz	43	46	49	jΩ
Input impedance, imaginary		@ 3600 MHz	-1	2	5	Ω
Input impedance, real		@ 3800 MHz	42.5	45.5	48.5	Ω
Input impedance, imaginary		@ 3800 MHz	0	3	6	jΩ
Insertion loss	IL				0.30	dB
Insertion loss	IL	25 °C			0.25	dB
Isolation	ISO		20			dB
Isolation	ISO	3200 MHz to 4000 MHz	16			dB
Return loss	RL		22			dB
Intermodulation distortion ²	IMD	2 x 5W CW tones, 5 MHz spacing	60			dBc
Group delay					2.0	ns
2nd harmonic			10			dBc
3rd harmonic			5			dBc
Out of band resonance point			3200		4000	MHz

¹ Performance is guaranteed under the conditions listed in this table and over the operating temperature range.

² See Skyworks Application Note, *Intermodulation Distortion Measurements of Ferrites*, document number 201537 for further details.

³ Performance will not degrade by > 10% (Insertion loss >20%) with an operating temperature of up to 130°C.

Table 3. SKYFR-001746 Plating Specification

Section	Base Material	Plating
Pins	Brass	Silver
Housing	Steel	Silver

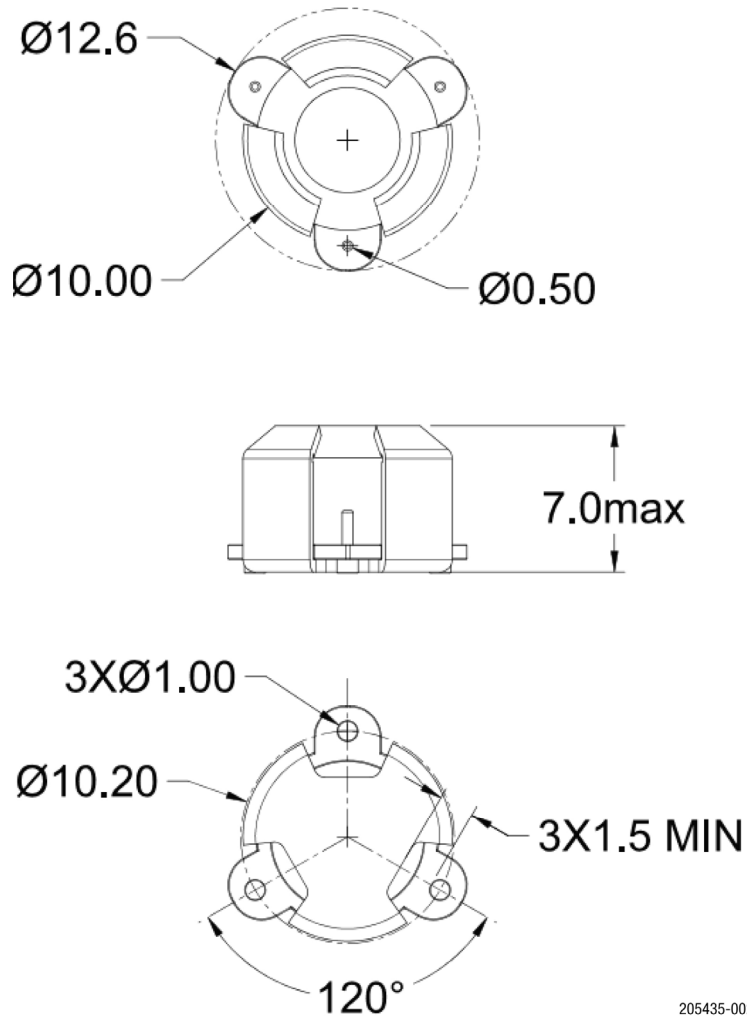

Notes:

1. All dimensions in millimeters.
2. Tolerance: ± 0.2 mm unless otherwise specified.
3. Coplanarity specification: 0.1 mm maximum.
4. Model number, lot code, and port designation printed on top side of device.

Figure 2. SKYFR-001746 Package Dimensions and PCB Footprint

Ordering Information

Part Number	Product Description	Evaluation Board Part Number
SKYFR-001746	3400 to 3800 MHz Single-Junction Robust Lead Circulator	TFX-00294 / PCB-00263

Copyright © 2019 Skyworks Solutions, Inc. All Rights Reserved.

Information in this document is provided in connection with Skyworks Solutions, Inc. (“Skyworks”) products or services. These materials, including the information contained herein, are provided by Skyworks as a service to its customers and may be used for informational purposes only by the customer. Skyworks assumes no responsibility for errors or omissions in these materials or the information contained herein. Skyworks may change its documentation, products, services, specifications or product descriptions at any time, without notice. Skyworks makes no commitment to update the materials or information and shall have no responsibility whatsoever for conflicts, incompatibilities, or other difficulties arising from any future changes.

No license, whether express, implied, by estoppel or otherwise, is granted to any intellectual property rights by this document. Skyworks assumes no liability for any materials, products or information provided hereunder, including the sale, distribution, reproduction or use of Skyworks products, information or materials, except as may be provided in Skyworks Terms and Conditions of Sale.

THE MATERIALS, PRODUCTS AND INFORMATION ARE PROVIDED “AS IS” WITHOUT WARRANTY OF ANY KIND, WHETHER EXPRESS, IMPLIED, STATUTORY, OR OTHERWISE, INCLUDING FITNESS FOR A PARTICULAR PURPOSE OR USE, MERCHANTABILITY, PERFORMANCE, QUALITY OR NON-INFRINGEMENT OF ANY INTELLECTUAL PROPERTY RIGHT; ALL SUCH WARRANTIES ARE HEREBY EXPRESSLY DISCLAIMED. SKYWORKS DOES NOT WARRANT THE ACCURACY OR COMPLETENESS OF THE INFORMATION, TEXT, GRAPHICS OR OTHER ITEMS CONTAINED WITHIN THESE MATERIALS. SKYWORKS SHALL NOT BE LIABLE FOR ANY DAMAGES, INCLUDING BUT NOT LIMITED TO ANY SPECIAL, INDIRECT, INCIDENTAL, STATUTORY, OR CONSEQUENTIAL DAMAGES, INCLUDING WITHOUT LIMITATION, LOST REVENUES OR LOST PROFITS THAT MAY RESULT FROM THE USE OF THE MATERIALS OR INFORMATION, WHETHER OR NOT THE RECIPIENT OF MATERIALS HAS BEEN ADVISED OF THE POSSIBILITY OF SUCH DAMAGE.

Skyworks products are not intended for use in medical, lifesaving or life-sustaining applications, or other equipment in which the failure of the Skyworks products could lead to personal injury, death, physical or environmental damage. Skyworks customers using or selling Skyworks products for use in such applications do so at their own risk and agree to fully indemnify Skyworks for any damages resulting from such improper use or sale.

Customers are responsible for their products and applications using Skyworks products, which may deviate from published specifications as a result of design defects, errors, or operation of products outside of published parameters or design specifications. Customers should include design and operating safeguards to minimize these and other risks. Skyworks assumes no liability for applications assistance, customer product design, or damage to any equipment resulting from the use of Skyworks products outside of stated published specifications or parameters.

Skyworks and the Skyworks symbol are trademarks or registered trademarks of Skyworks Solutions, Inc. or its subsidiaries in the United States and other countries. Third-party brands and names are for identification purposes only, and are the property of their respective owners. Additional information, including relevant terms and conditions, posted at www.skyworksinc.com, are incorporated by reference.