

DATA SHEET

SKY13286-359LF: 0.1 to 6.0 GHz High Isolation SPDT Absorptive Switch

Applications

- GSM, PCS, WCDMA base stations
- 2.4 and 5.8 GHz ISM devices
- Wireless local loops

Features

- Single, positive voltage control: 0 to 3 and 0 to 5 V
- High isolation 64 dB at 1 GHz and 2 GHz
- Integrated silicon CMOS driver
- Absorptive
- Small, QFN (16-pin, 4 x 4 mm) Pb-free package (MSL1, 260 °C per JEDEC J-STD-020)



Skyworks Green™ products are compliant with all applicable legislation and are halogen-free. For additional information, refer to *Skyworks Definition of Green™*, document number SQ04-0074.

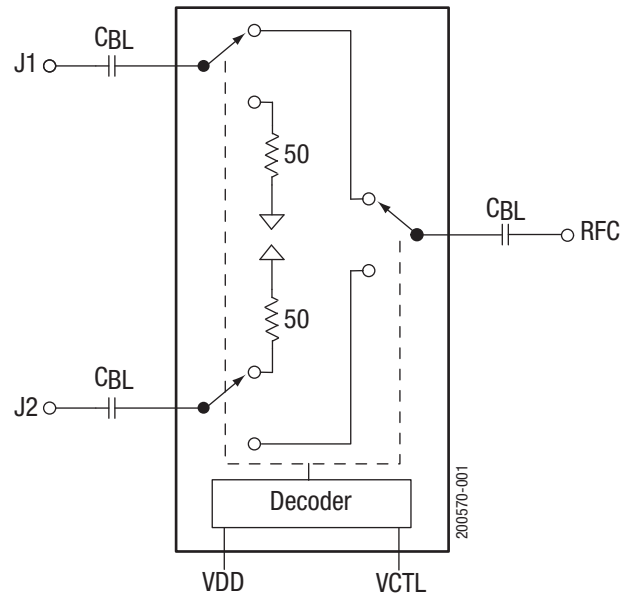

Figure 1. SKY13286-359LF Block Diagram

Description

The SKY13286-359LF is a GaAs pHEMT FET high-isolation, absorptive switch. The device is an ideal component for base station applications in which synthesizer isolation is critical.

The device is provided in a 4 x 4 mm, 16-pin Quad Flat No-Lead (QFN) package. A functional block diagram is shown in Figure 1. The pin configuration and package are shown in Figure 2. Signal pin assignments and functional pin descriptions are provided in Table 1.

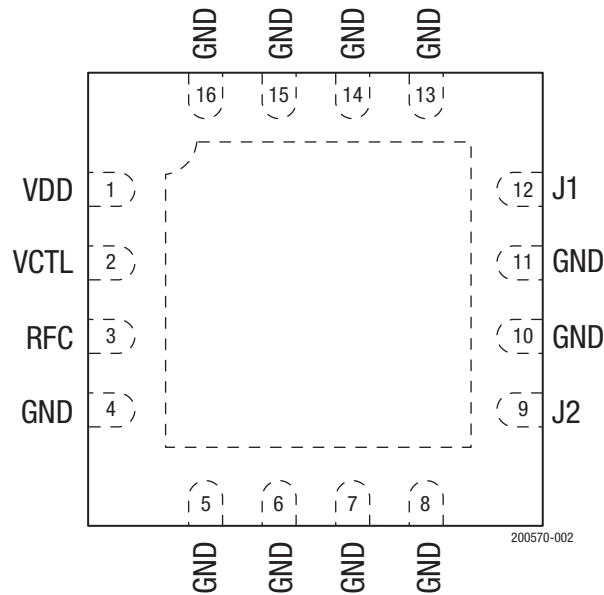

Figure 2. SKY13286-359LF Pinout (Top View)

Table 1. SKY13286-359LF Signal Descriptions

Pin	Name	Description	Pin	Name	Description
1	VDD	DC power supply	9	J2	RF output 2
2	VCTL	DC switch control pin. Switches insertion loss state from RFC to J1 or J2 (see Table 5).	10	GND	Ground
3	RFC	RF input	11	GND	Ground
4	GND	Ground	12	J1	RF output 1
5	GND	Ground	13	GND	Ground
6	GND	Ground	14	GND	Ground
7	GND	Ground	15	GND	Ground
8	GND	Ground	16	GND	Ground

Electrical and Mechanical Specifications

The absolute maximum ratings of the SKY13286-359LF are provided in Table 2. Recommended operating conditions are specified in Table 3 and electrical specifications are provided in Table 4.

Typical performance characteristics of the SKY13286-359LF are illustrated in Figures 3 through 9.

The state of the SKY13286-359LF is determined by the logic provided in Table 5.

Table 2. SKY13286-359LF Absolute Maximum Ratings¹

Parameter	Symbol	Minimum	Typical	Maximum	Units
Supply voltage	VDD	2.7		5.5	V
RF input power @ >500 MHz	V _i		1		W
Operating temperature	T _{OP}	-40		+95	°C
Storage temperature	T _{STG}	-65		+150	°C

¹ Exposure to maximum rating conditions for extended periods may reduce device reliability. There is no damage to device with only one parameter set at the limit and all other parameters set at or below their nominal value. Exceeding any of the limits listed here may result in permanent damage to the device.

ESD HANDLING: Although this device is designed to be as robust as possible, electrostatic discharge (ESD) can damage this device. This device must be protected at all times from ESD when handling or transporting. Static charges may easily produce potentials of several kilovolts on the human body or equipment, which can discharge without detection. Industry-standard ESD handling precautions should be used at all times.

Table 3. Recommended Operating Conditions

Parameter	Symbol	Test Condition	Min	Typical	Max	Units
Switching characteristics:						
Rise, fall		10/90% or 90/10% RF		30		ns
On/off		50% control to 90/10% RF		50		ns
Video feedthrough		T _{RISE} = 3 ns, measurement bandwidth = 500 MHz		25		mV
Input power for 1 dB compression	P _{INPUT}	VDD = 3V, 0.7-2.0 GHz VDD = 5 V, 0.7-2.0 GHz	+26	+23 +30		dBm dBm
2 nd harmonic	2f _o	f _o = 2400 MHz, P _{IN} = -15 dBm		-80		dBm
Third order intercept point	IP3	For 2-tone input power, +8 dBm/tone, 1 MHz spacing: VDD = 3.3 V, 0.7-1.0 GHz VDD = 5.0 V, 0.7-1.0 GHz VDD = 3.3 V, 1.0-2.0 GHz VDD = 5.0 V, 1.0-2.0 GHz	+45 +45	+49 +47 +43 +46		dBm dBm dBm dBm
Control voltage: ¹						
Low with VDD = 5 V	V _{CTL_LOW}		0		0.5	V
High with VDD = 5 V	V _{CTL_HIGH}		2.7		VDD	V
Low with VDD = 3.3 V	V _{CTL_LOW}		0		0.5	V
High with VDD = 3.3 V	V _{CTL_HIGH}		2.5		3.3	V
Supply current		VDD = 5 V			100	μA
Control current		V _{CTL} = low or high		5		μA
Supply voltage			2.7		5.0	V

¹ VDD must be applied before a Vctl high signal. A latch-up condition may occur if a logic high signal is applied before the VDD voltage. Control voltages switch the VDD voltage to the GaAs switch.

Table 4. SKY13286-359LF Electrical Specifications¹
 (V_{CTL} = 0 V/3 V, V_{DD} = 5 V, T_{OP} = +25 °C, P_{INPUT} = 0 dBm, Characteristic Impedance [Z₀] = 50 Ω, Unless Otherwise Noted)

Parameter	Symbol	Test Condition	Min	Typical	Max	Units
CW insertion loss	IL	0.1 to 2.0 GHz		0.8	1.10	dB
		2.0 to 3.0 GHz		0.8	1.25	dB
		3.0 to 4.0 GHz		1.0	1.35	dB
		4.0 to 6.0 GHz		1.5	1.80	dB
Isolation	Iso	0.1 to 2.0 GHz	60	62		dB
		2.0 to 3.0 GHz	58	62		dB
		3.0 to 4.0 GHz	55	58		dB
		4.0 to 6.0 GHz	40	42		dB
Return loss (insertion loss state) ²	RL	0.1 to 2.0 GHz	10	22		dB
		2.0 to 3.0 GHz	15	22		dB
		3.0 to 4.0 GHz	13	18		dB
		4.0 to 6.0 GHz	10	12		dB
Return loss (isolation state) ²	RL	0.1 to 2.0 GHz	10	12		dB
		2.0 to 3.0 GHz	12	15		dB
		3.0 to 4.0 GHz	12	15		dB
		4.0 to 6.0 GHz	11	13		dB
Insertion loss settling time	ΔIL	Insertion loss in db measured @ 1 μs (referenced to a rising 10% RF level on J1 & J2) minus the CW insertion loss in dB. Freq = 2 GHz, T _{OP} = +25 °C, V _{CTL} = 5 V, pulse width = 1.15 ms, 50% duty cycle.			0.40	dB

¹ Performance is guaranteed only under the conditions listed in this table.

² Lower frequency return loss is dependent on DC blocks.

Typical Performance Characteristics

(V_{CTL} = 0 V/3 V, V_{DD} = 5 V, T_{OP} = +25 °C, P_{IN} = 0 dBm, Characteristic Impedance [Z₀] = 50 Ω, Unless Otherwise Noted)

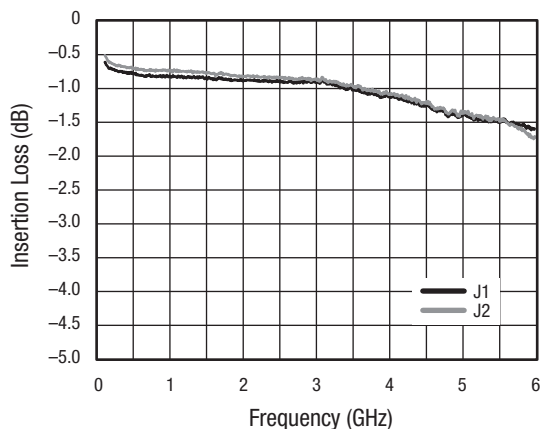

Figure 3. Insertion Loss vs Frequency

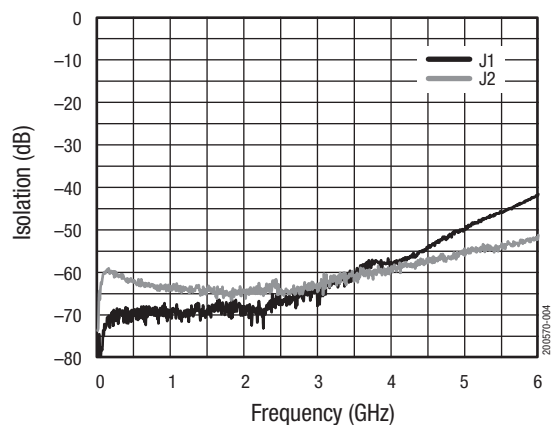

Figure 4. Isolation vs Frequency

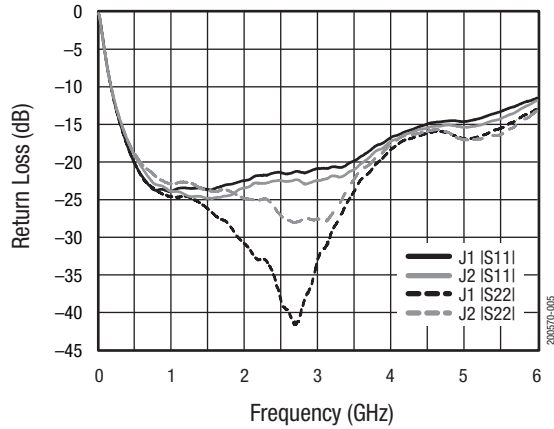

Figure 5. Return Loss vs Frequency (Insertion Loss State)

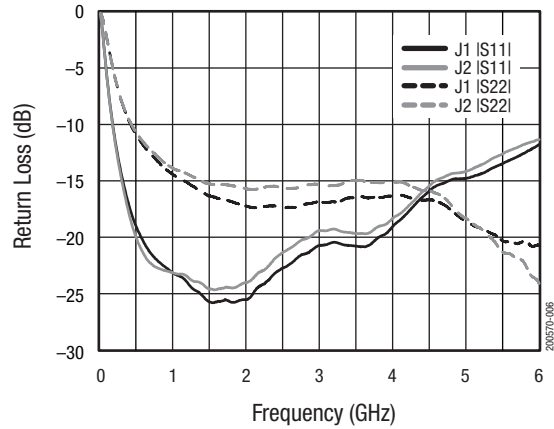

Figure 6. Return Loss vs Frequency (Isolation State)

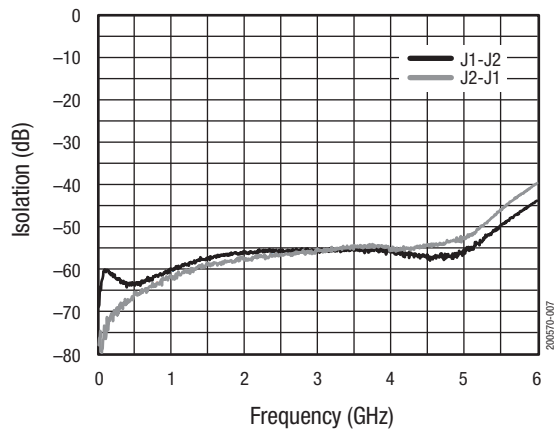

Figure 7. Output to Output Isolation

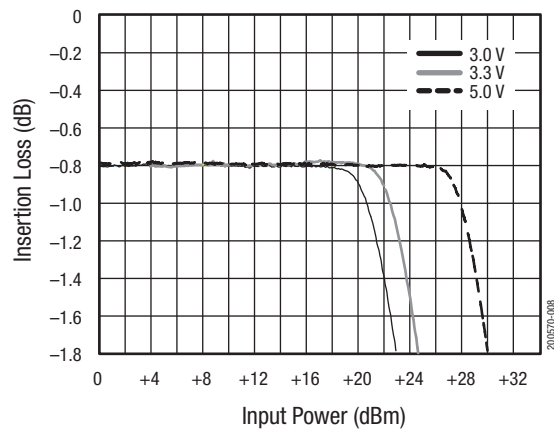

Figure 8. Insertion Loss vs Input Power Over Voltage

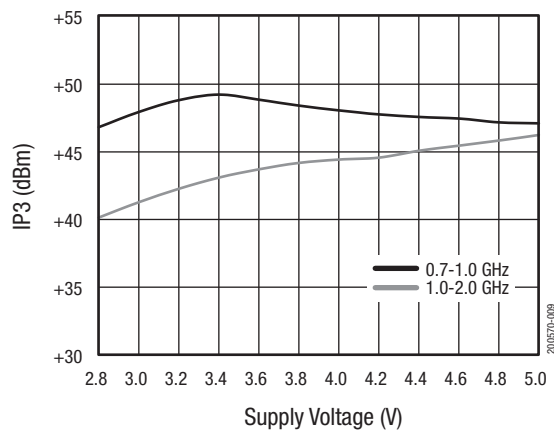

Figure 9. IP3 vs VDD Supply Voltage

Table 5. SKY13286-359LF Truth Table

VCTL	RFC to J1	RFC to J2
0	Insertion loss	Isolation
1	Isolation	Insertion loss

Evaluation Board Description

The SKY13286-359LF Evaluation Board is used to test the performance of the SKY13286-359LF SPDT absorptive switch. An assembly drawing for the Evaluation Board is shown in Figure 10.

Package Dimensions

The PCB layout footprint for the SKY13286-359LF is shown in Figure 11. Typical part markings are noted in Figure 12. Package dimensions are shown in Figure 13, and tape and reel dimensions are provided in Figure 14.

Package and Handling Information

Instructions on the shipping container label regarding exposure to moisture after the container seal is broken must be followed. Otherwise, problems related to moisture absorption may occur when the part is subjected to high temperature during solder assembly.

The SKY13286-359LF is rated to Moisture Sensitivity Level 1 (MSL1) at 260 °C. It can be used for lead or lead-free soldering. For additional information, refer to the Skyworks Application Note, *Solder Reflow Information*, document number 200164.

Care must be taken when attaching this product, whether it is done manually or in a production solder reflow environment. Production quantities of this product are shipped in a standard tape and reel format.

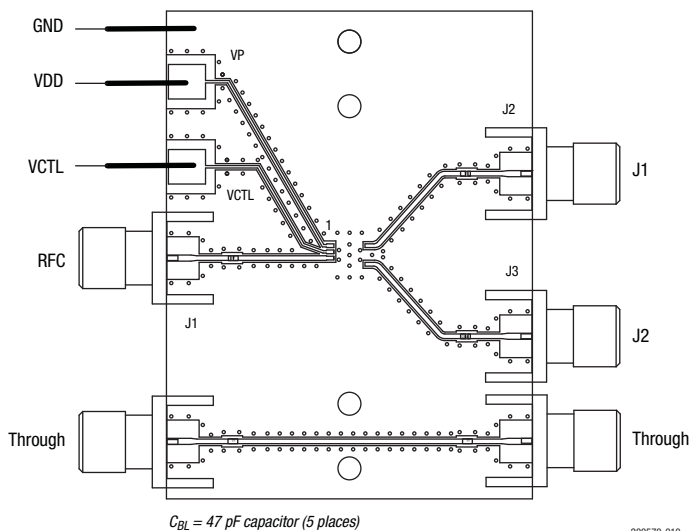

Figure 10. SKY13286-359LF Evaluation Board Assembly Diagram

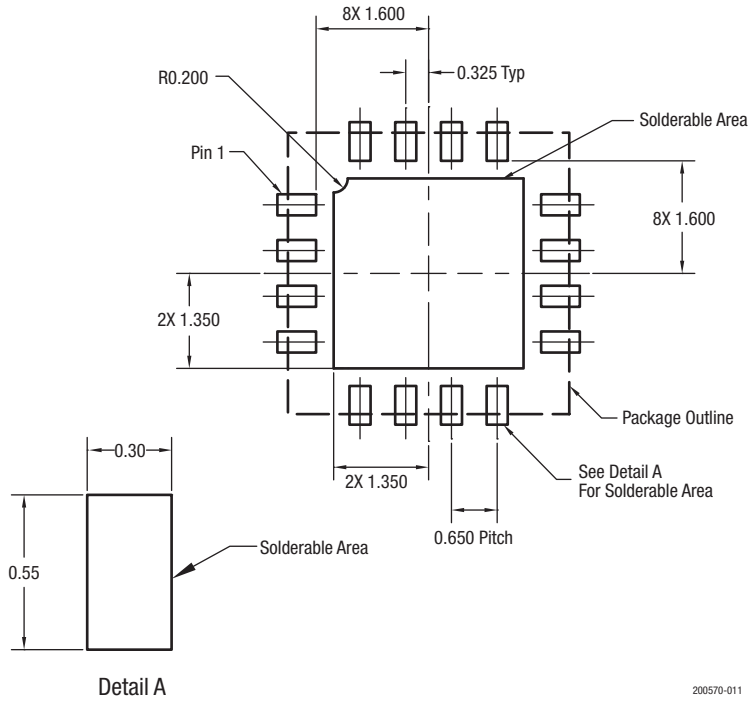

Figure 11. SKY13286-359LF PCB Layout Footprint

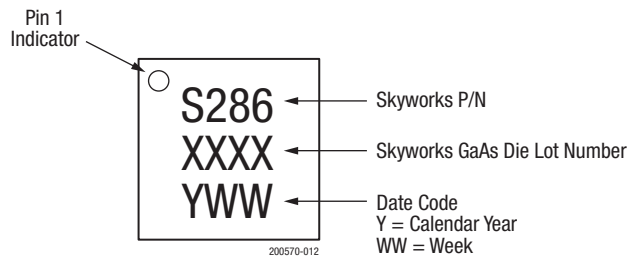
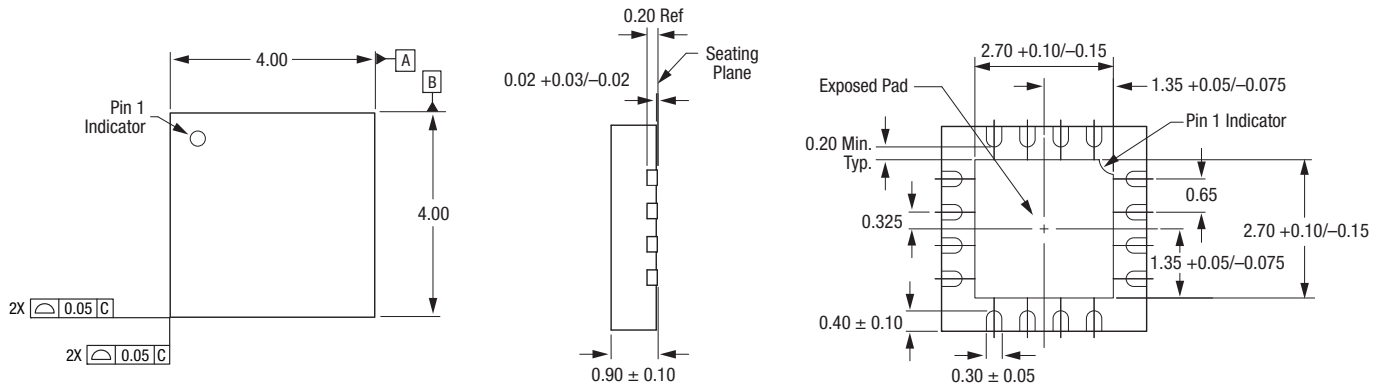

Figure 12. Typical Part Markings

DATA SHEET • SKY13286-359LF: SPDT ABSORPTIVE SWITCH



All dimensions are in millimeters

200570-013

Figure 13. SKY13286-359LF Package Dimensions

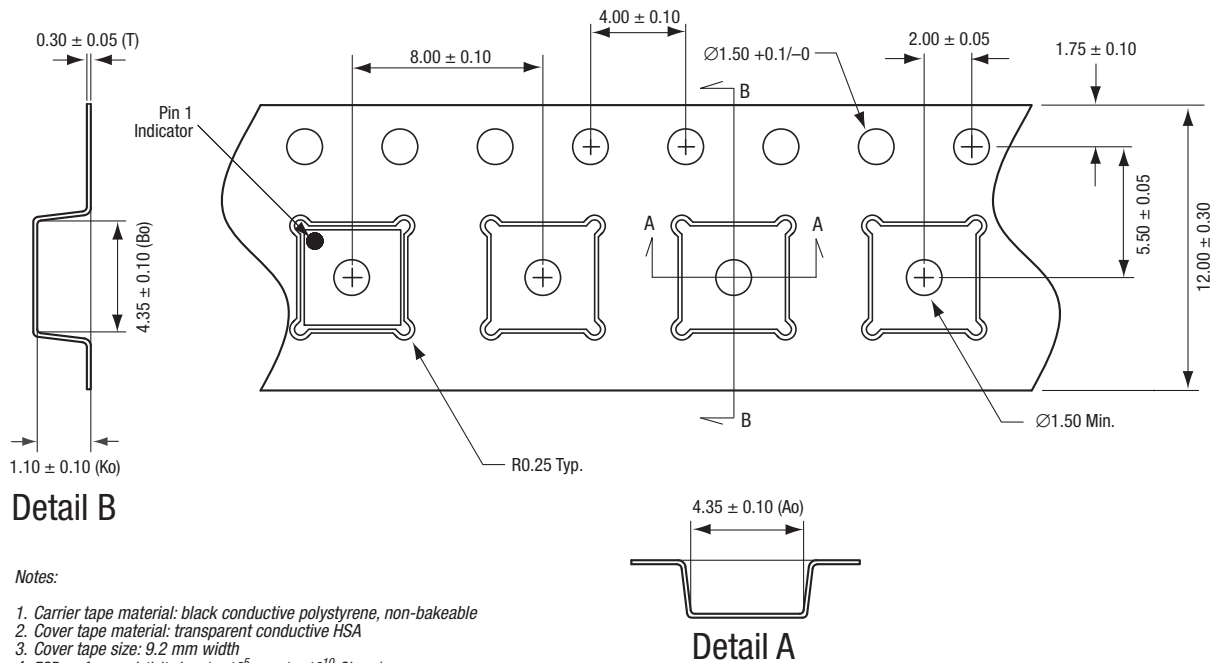

Notes:

1. Carrier tape material: black conductive polystyrene, non-bakeable
2. Cover tape material: transparent conductive HSA
3. Cover tape size: 9.2 mm width
4. ESD surface resistivity is $\geq 1 \times 10^5 \sim \leq 1 \times 10^{10}$ Ohms/square per EIA, JEDEC TNR Specification.
5. All measurements are in millimeters

200570-014

Figure 14. SKY13286-359LF Tape and Reel Dimensions

Ordering Information

Model Name	Manufacturing Part Number	Evaluation Board Part Number
SKY13286-359LF: SPDT Absorptive Switch	SKY13286-359LF	SKY13286-359LF-EVB

Copyright © 2009, 2011-2014, 2017 Skyworks Solutions, Inc. All Rights Reserved.

Information in this document is provided in connection with Skyworks Solutions, Inc. ("Skyworks") products or services. These materials, including the information contained herein, are provided by Skyworks as a service to its customers and may be used for informational purposes only by the customer. Skyworks assumes no responsibility for errors or omissions in these materials or the information contained herein. Skyworks may change its documentation, products, services, specifications or product descriptions at any time, without notice. Skyworks makes no commitment to update the materials or information and shall have no responsibility whatsoever for conflicts, incompatibilities, or other difficulties arising from any future changes.

No license, whether express, implied, by estoppel or otherwise, is granted to any intellectual property rights by this document. Skyworks assumes no liability for any materials, products or information provided hereunder, including the sale, distribution, reproduction or use of Skyworks products, information or materials, except as may be provided in Skyworks Terms and Conditions of Sale.

THE MATERIALS, PRODUCTS AND INFORMATION ARE PROVIDED "AS IS" WITHOUT WARRANTY OF ANY KIND, WHETHER EXPRESS, IMPLIED, STATUTORY, OR OTHERWISE, INCLUDING FITNESS FOR A PARTICULAR PURPOSE OR USE, MERCHANTABILITY, PERFORMANCE, QUALITY OR NON-INFRINGEMENT OF ANY INTELLECTUAL PROPERTY RIGHT; ALL SUCH WARRANTIES ARE HEREBY EXPRESSLY DISCLAIMED. SKYWORKS DOES NOT WARRANT THE ACCURACY OR COMPLETENESS OF THE INFORMATION, TEXT, GRAPHICS OR OTHER ITEMS CONTAINED WITHIN THESE MATERIALS. SKYWORKS SHALL NOT BE LIABLE FOR ANY DAMAGES, INCLUDING BUT NOT LIMITED TO ANY SPECIAL, INDIRECT, INCIDENTAL, STATUTORY, OR CONSEQUENTIAL DAMAGES, INCLUDING WITHOUT LIMITATION, LOST REVENUES OR LOST PROFITS THAT MAY RESULT FROM THE USE OF THE MATERIALS OR INFORMATION, WHETHER OR NOT THE RECIPIENT OF MATERIALS HAS BEEN ADVISED OF THE POSSIBILITY OF SUCH DAMAGE.

Skyworks products are not intended for use in medical, lifesaving or life-sustaining applications, or other equipment in which the failure of the Skyworks products could lead to personal injury, death, physical or environmental damage. Skyworks customers using or selling Skyworks products for use in such applications do so at their own risk and agree to fully indemnify Skyworks for any damages resulting from such improper use or sale.

Customers are responsible for their products and applications using Skyworks products, which may deviate from published specifications as a result of design defects, errors, or operation of products outside of published parameters or design specifications. Customers should include design and operating safeguards to minimize these and other risks. Skyworks assumes no liability for applications assistance, customer product design, or damage to any equipment resulting from the use of Skyworks products outside of stated published specifications or parameters.

Skyworks and the Skyworks symbol are trademarks or registered trademarks of Skyworks Solutions, Inc., in the United States and other countries. Third-party brands and names are for identification purposes only, and are the property of their respective owners. Additional information, including relevant terms and conditions, posted at www.skyworksinc.com, are incorporated by reference.