

DATA SHEET

SKY13314-374LF: 0.1 to 6.0 GHz GaAs SPDT Switch

Applications

- Dual-band WLAN systems

Features

- Positive low voltage control: 0 and 3.3 V
- Low insertion loss: 0.45 dB @ 2.5 GHz and 0.60 dB @ 6.0 GHz
- Excellent linearity performance: P1dB = +31 dBm
- Advanced pHEMT process
- Ultra-thin, miniature MLPD (6-pin, 1.5 x 1.5 x 0.45 mm) package (MSL1, 260 °C per JEDEC J-STD-020)
- For RoHS and other product compliance information, see the [Skyworks Certificate of Conformance](#)

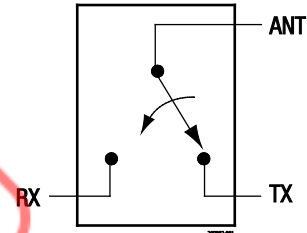

Figure 1. SKY13314-374LF Block Diagram

Description

The SKY13314-374LF is a pHEMT GaAs I/C antenna switch. Switching between the antenna and TX or RX ports is accomplished with two control voltages. The low-loss, high isolation, high linearity, small size and low cost make this switch ideal for all dual-band WLAN systems that operate at 2.4 to 2.5 GHz and 4.9 to 5.9 GHz.

The switch is manufactured in a compact, 1.5 x 1.5 mm, 6-pin exposed pad plastic Micro Leadframe Package Dual (MLPD) package.

A functional block diagram is shown in Figure 1. The pin configuration and package are shown in Figure 2. Signal pin assignments and functional pin descriptions are provided in Table 1.

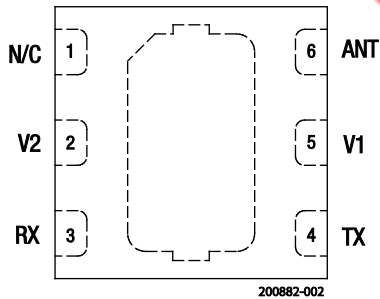

Figure 2. SKY13314-374LF Pinout (Top View)

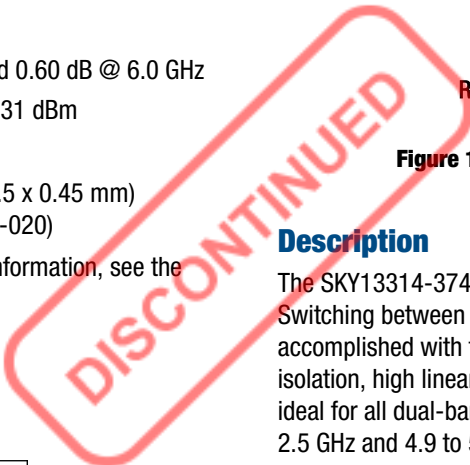

Table 1. SKY13314-374LF Signal Descriptions

Pin	Name	Description	Pin	Name	Description
1	N/C	No connection	4	TX	RF port (must be DC blocked)
2	V2	DC control voltage	5	V1	DC control voltage
3	RX	RF port (must be DC blocked)	6	ANT	RF common port (must be DC blocked)

Electrical and Mechanical Specifications

The absolute maximum ratings of the SKY13314-374LF are provided in Table 2. Electrical specifications are provided in Table 3.

Typical performance characteristics of the SKY13314-374LF are illustrated in Figures 3 through 9.

The state of the SKY13314-374LF is determined by the logic provided in Table 4.

Table 2. SKY13314-374LF Absolute Maximum Ratings¹

Parameter	Symbol	Minimum	Maximum	Units
Input power @ 0 and 3 V	P _{IN}		+33	dBm
Input power @ 0 and 5 V	P _{IN}		+35	dBm
Operating voltage	V _{CTL}		6.0	V
Storage temperature	T _{STG}	-65	+150	°C
Operating temperature	T _{OP}	-40	+85	°C

ESD HANDLING: *Although this device is designed to be as robust as possible, electrostatic discharge (ESD) can damage this device. This device must be protected at all times from ESD when handling or transporting. Static charges may easily produce potentials of several kilovolts on the human body or equipment, which can discharge without detection. Industry-standard ESD handling precautions should be used at all times.*

Table 3. SKY13314-374LF Electrical Specification¹**($V_{CTL} = 0\text{ V}$ and $+3.3\text{ V}$, $T_{OP} = +25\text{ }^{\circ}\text{C}$, $P_{IN} = 0\text{ dBm}$, Characteristic Impedance [Z_0] = $50\text{ }\Omega$, Unless Otherwise Noted)**

Parameter	Symbol	Test Condition	Min	Typ	Max	Units
Insertion loss, ANT to TX and RX ports		2.4 to 2.5 GHz		0.45	0.65	dB
		0.1 to 3.0 GHz		0.50	0.70	dB
		3.0 to 6.0 GHz		0.60	0.85	dB
Isolation, ANT to TX and RX ports		2.4 to 2.5 GHz	19	22		dB
		0.1 to 3.0 GHz	18	21		dB
		3.0 to 6.0 GHz	18	21		dB
Return loss, ANT to TX and RX ports (insertion loss state) ²		2.4 to 2.5 GHz	14	21		dB
		0.1 to 3.0 GHz	12	18		dB
		3.0 to 6.0 GHz	12	15		dB
Switching characteristics: Rise/fall time On/off time		10/90% or 90/10% RF		15		ns
		50% V_{CTL} to 90/10% RF		30		ns
Video feedthrough		$T_{RISE} = 1\text{ ns @ }500\text{ MHz}$		50		mV
Input power for 1 dB compression	P1dB	$V_{CTL} = 0$ and 3.3 V : 2.4 to 2.5 GHz 4.9 to 5.9 GHz		+31		dBm
				+31		dBm
Input IP3	IIP3	For two-tone input power = $+17\text{ dBm/ tone}$, 1 MHz spacing, $V_{CTL} = 0$ and 3.3 V , 2.4-2.5 GHz		+47		dBm
Error vector magnitude	EVM	802.11a, 54 Mbps, $P_{IN} = <+20.5\text{ dBm}$, $V_{CTL} = 3\text{ V}$ 802.11g, 54 Mbps, $P_{IN} = <+24.5\text{ dBm}$, $V_{CTL} = 3\text{ V}$		2.5		%
				2.5		%
Control voltage: High Low	V_{CTL_H}		1.80	3.30	5.00	V
	V_{CTL_L}			0	0.25	V
Leakage current		V_{CTL_H} and V_{CTL_L}		5	50	μA

¹ Performance is guaranteed only under the conditions listed in this table.² Low frequency return loss is limited by the value of DC blocking capacitors (15 pF).

Typical Performance Characteristics

($V_{CTL} = 0\text{ V}$ and $+3.3\text{ V}$, $T_{OP} = +25\text{ }^{\circ}\text{C}$, $P_{IN} = 0\text{ dBm}$, Characteristic Impedance [Z_0] = $50\text{ }\Omega$, Blocking Capacitors = 15 pF , Unless Otherwise Noted)

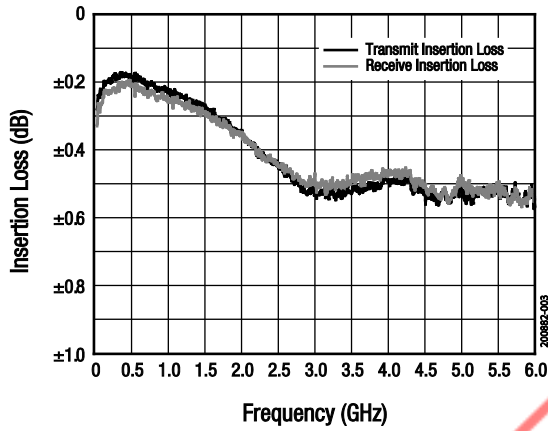

Figure 3. Typical Insertion Loss

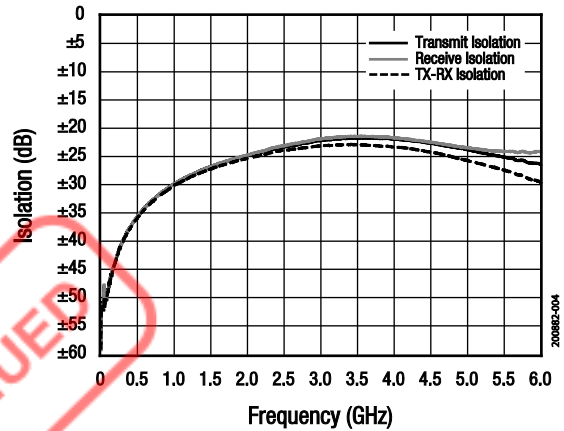

Figure 4. Typical Isolation

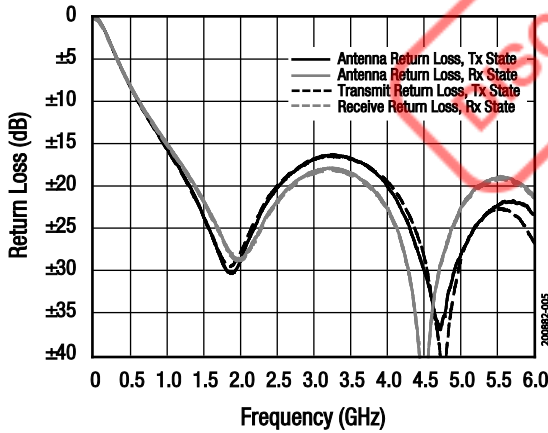

Figure 5. Typical Return Loss

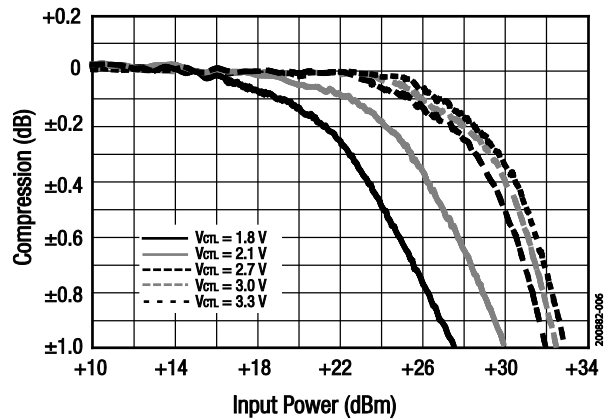

Figure 6. Typical Compression, 2.4-2.5 GHz

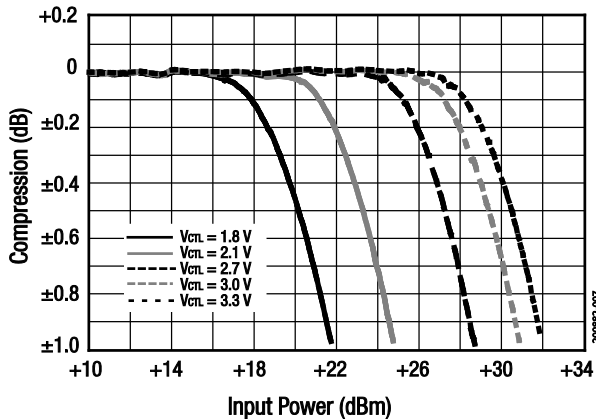

Figure 7. Typical Compression, 4.9-5.9 GHz

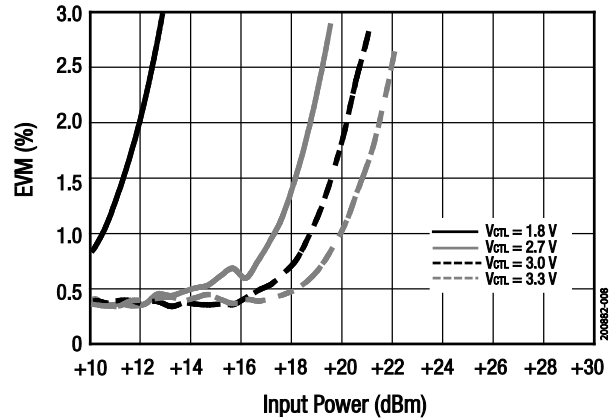

Figure 8. Typical 802.11a EVM, 4.9-5.9 GHz

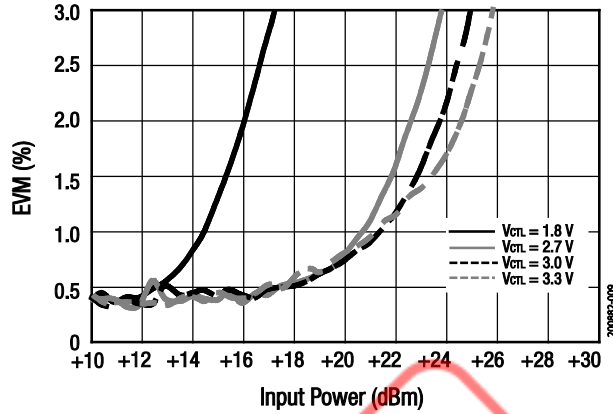
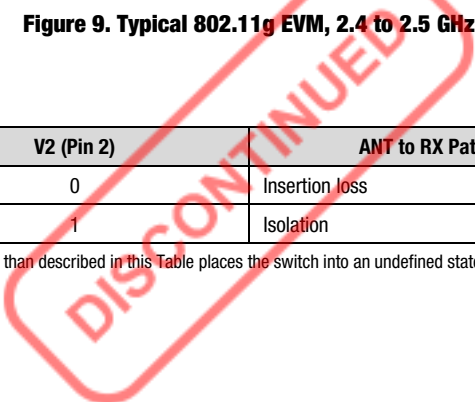

Figure 9. Typical 802.11g EVM, 2.4 to 2.5 GHz

Table 5. SKY13314-374LF Truth Table¹

V1 (Pin 5)	V2 (Pin 2)	ANT to RX Path	ANT to TX Path
1	0	Insertion loss	Isolation
0	1	Isolation	Insertion loss

¹ "1" = +1.8 V to +5.0 V. "0" = 0 V to +0.25 V. Any state other than described in this Table places the switch into an undefined state. An undefined state will not damage the device.



Evaluation Board Description

The SKY13314-374LF Evaluation Board is used to test the performance of the SKY13314-374LF SPDT Switch. An Evaluation Board schematic diagram is provided in Figure 10. An assembly drawing for the Evaluation Board is shown in Figure 11.

Package Dimensions

The PCB layout footprint for the SKY13314-374LF is provided in Figure 12. Typical part markings are shown in Figure 13. Package dimensions are shown in Figure 14, and tape and reel dimensions are provided in Figure 15.

Package and Handling Information

Instructions on the shipping container label regarding exposure to moisture after the container seal is broken must be followed. Otherwise, problems related to moisture absorption may occur when the part is subjected to high temperature during solder assembly.

The SKY13314-374LF is rated to Moisture Sensitivity Level 1 (MSL1) at 260 °C. It can be used for lead or lead-free soldering.

Care must be taken when attaching this product, whether it is done manually or in a production solder reflow environment. Production quantities of this product are shipped in a standard tape and reel format. For packaging details, refer to the Skyworks Application Note, *Discrete Devices and IC Switch/Attenuators Tape and Reel Package Orientation*, document number 200083.

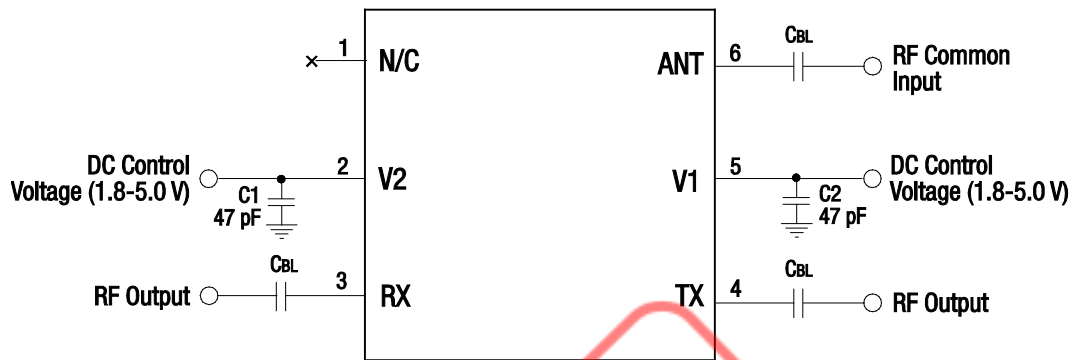

C_{BL} = 22 pF for 2.4-6.0 GHz operation.
Exposed ground paddle should be grounded
for best performance.

20082-010

Figure 10. SKY13314-374LF Evaluation Board Schematic

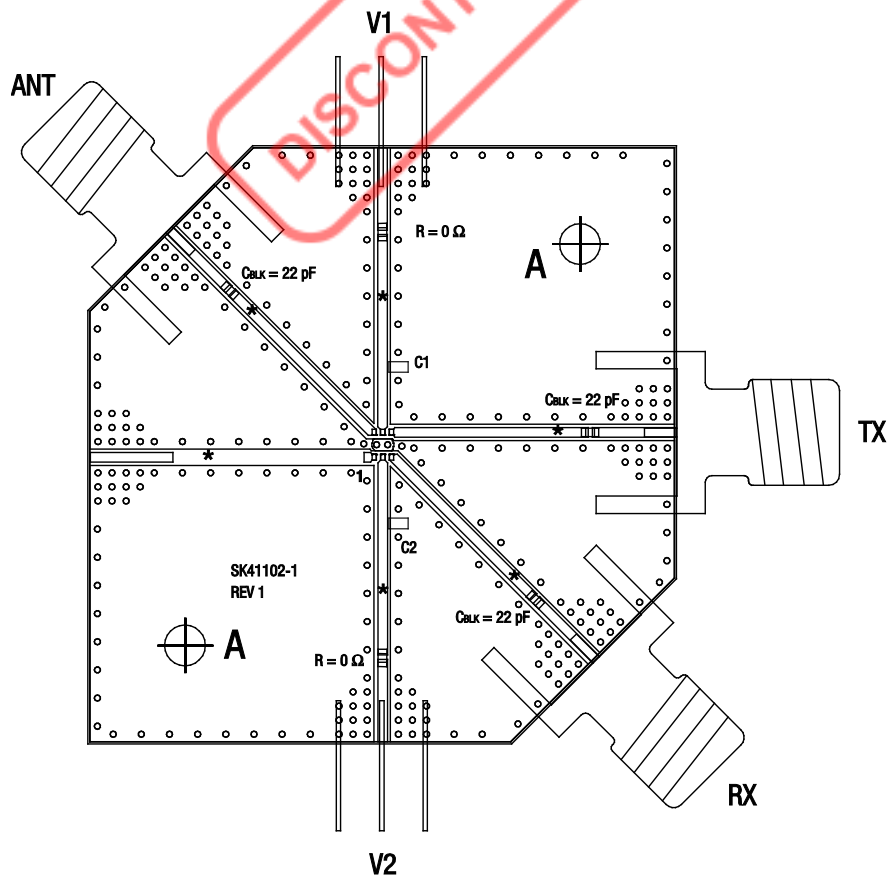

R = 0 Ω (0402 size) 2 places
C_{BLK} = 15 pF (0402 size) 3 places
C1 and C2 = 47 pF (0402 size), 2 places

20082-011

Figure 11. SKY13314-374LF Evaluation Board Assembly Diagram

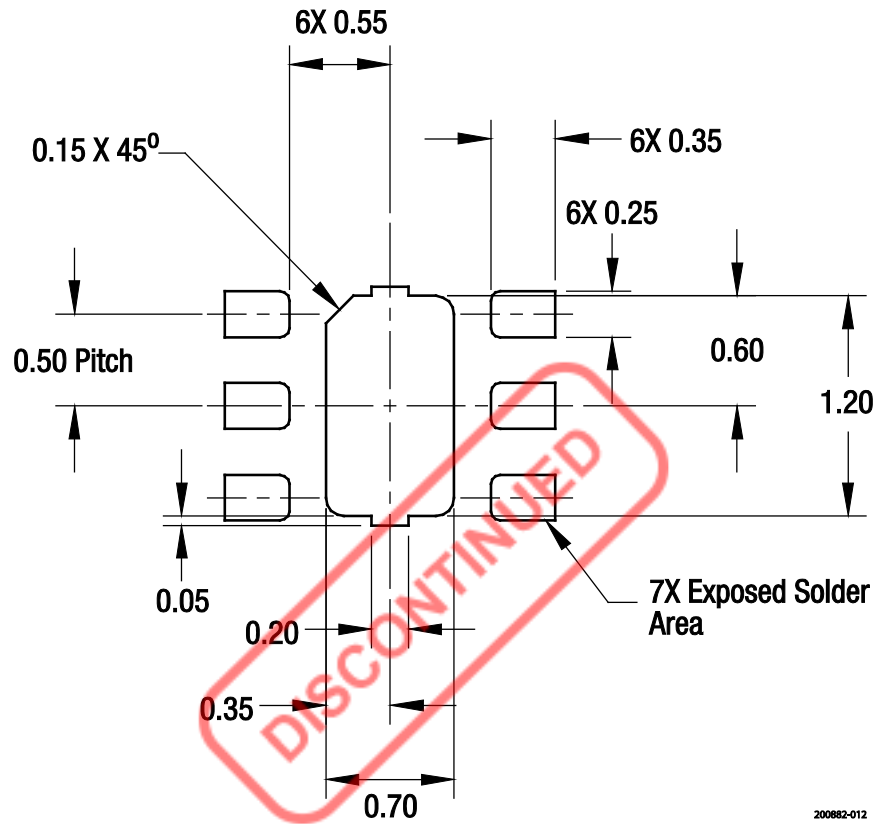

200882-012

Figure 12. SKY13314-374LF PCB Layout Footprint (Top View)

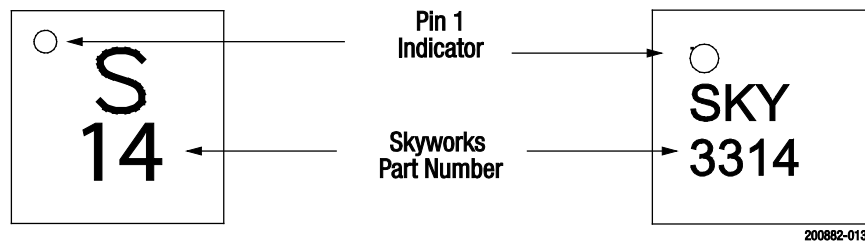

200882-013

Figure 13. Typical Part Markings (Top View)

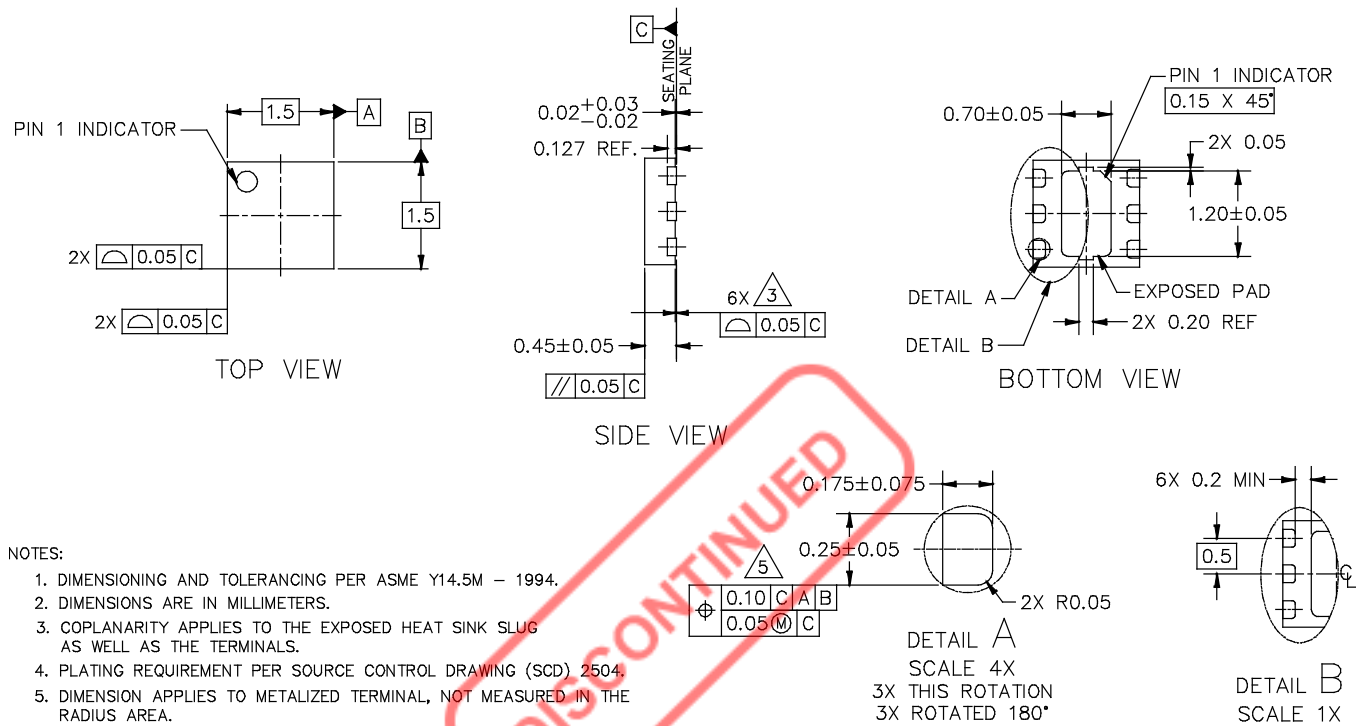

NOTES:

1. DIMENSIONING AND TOLERANCING PER ASME Y14.5M - 1994.
2. DIMENSIONS ARE IN MILLIMETERS.
3. COPLANARITY APPLIES TO THE EXPOSED HEAT SINK SLUG AS WELL AS THE TERMINALS.
4. PLATING REQUIREMENT PER SOURCE CONTROL DRAWING (SCD) 2504.
5. DIMENSION APPLIES TO METALIZED TERMINAL, NOT MEASURED IN THE RADIUS AREA.

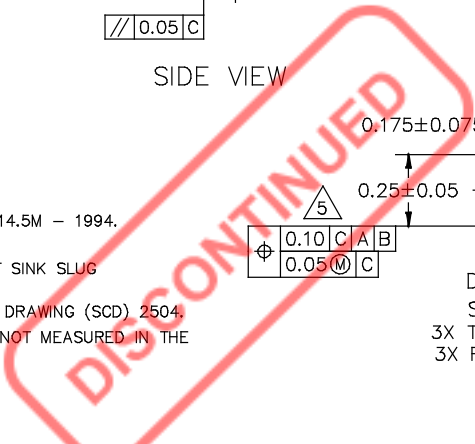
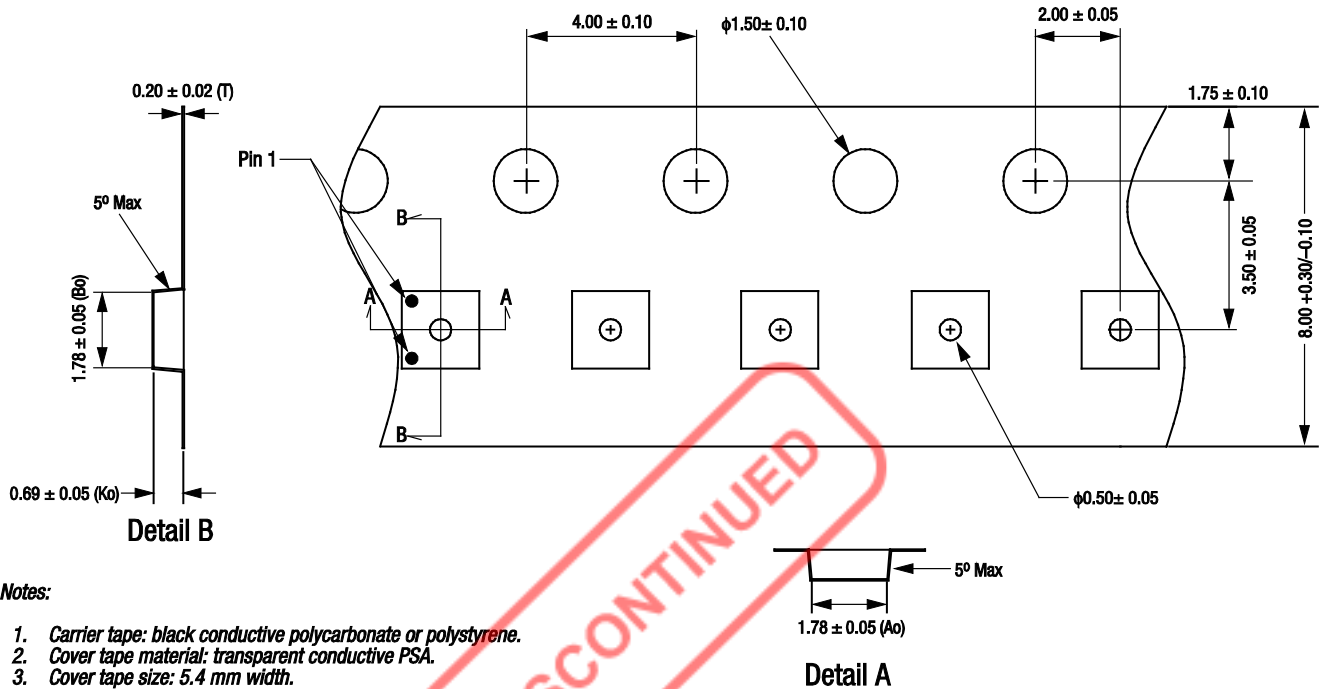

Figure 14. SKY13314-374LF Package Dimensions

200882-014



Notes:

1. Carrier tape: black conductive polycarbonate or polystyrene.
2. Cover tape material: transparent conductive PSA.
3. Cover tape size: 5.4 mm width.
4. All measurements are in millimeters.
5. Pin 1 orientation is in lower left corner for SOT-666 packages.
Pin 1 orientation is in upper left corner for 1.5 x 1.5 mm MLPD, QFN, and DFN packages.

Figure 15. SKY13314-374LF Tape and Reel Dimensions

200882-015

Ordering Information

Product Description	Product Part Number	Evaluation Board Part Number
SKY13314-374LF SPDT Switch	SKY13314-374LF	SKY13314-374-EVB



Copyright © 2008-2011, 2013, 2017-2018, 2026, Skyworks Solutions, Inc. All Rights Reserved.

Information in this document is provided in connection with Skyworks Solutions, Inc., and its subsidiaries (“Skyworks”) products or services. These materials, including the information contained herein, are provided by Skyworks as a service to its customers and may be used for informational purposes only by the customer. Skyworks assumes no responsibility for errors or omissions in these materials or the information contained herein. Skyworks may change its documentation, products, services, specifications or product descriptions at any time, without notice. Skyworks makes no commitment to update the materials or information and shall have no responsibility whatsoever for conflicts, incompatibilities, or other difficulties arising from any future changes.

No license, whether express, implied, by estoppel or otherwise, is granted to any intellectual property rights by this document. Skyworks assumes no liability for any materials, products or information provided hereunder, including the sale, distribution, reproduction or use of Skyworks products, information or materials, except as may be provided in Skyworks’ Terms and Conditions of Sale.

THE INFORMATION IN THIS DOCUMENT AND THE MATERIALS AND PRODUCTS DESCRIBED THEREIN ARE PROVIDED “AS IS” WITHOUT WARRANTY OF ANY KIND, WHETHER EXPRESS, IMPLIED, STATUTORY, OR OTHERWISE, INCLUDING FITNESS FOR A PARTICULAR PURPOSE OR USE, MERCHANTABILITY, PERFORMANCE, QUALITY OR NON-INFRINGEMENT OF ANY INTELLECTUAL PROPERTY RIGHT; ALL SUCH WARRANTIES ARE HEREBY EXPRESSLY DISCLAIMED. SKYWORKS DOES NOT WARRANT THE ACCURACY OR COMPLETENESS OF THE INFORMATION, TEXT, GRAPHICS OR OTHER ITEMS CONTAINED WITHIN THESE MATERIALS. SKYWORKS SHALL NOT BE LIABLE FOR ANY DAMAGES, INCLUDING BUT NOT LIMITED TO ANY SPECIAL, INDIRECT, INCIDENTAL, STATUTORY, OR CONSEQUENTIAL DAMAGES, INCLUDING WITHOUT LIMITATION, LOST REVENUES OR LOST PROFITS THAT MAY RESULT FROM THE USE OF THE MATERIALS OR INFORMATION, WHETHER OR NOT THE RECIPIENT OF MATERIALS HAS BEEN ADVISED OF THE POSSIBILITY OF SUCH DAMAGE.

Skyworks products are not designed, intended, authorized, or warranted for use or inclusion in life support or life endangering applications, devices, or systems where failure or inaccuracy might cause death or personal injury. Skyworks customers agree not to use or sell the Skyworks products for such applications, and further agree to, without limitation, fully defend, indemnify, and hold harmless Skyworks and its agents from and against any and all actions, suits, proceedings, costs, expenses, damages, and liabilities including attorneys’ fees arising out of or in connection with such improper use or sale.

Skyworks assumes no liability for applications assistance, customer product design, or damage to any equipment resulting from the use of Skyworks products outside of Skyworks’ published specifications or parameters. Customers are solely responsible for their products and applications using the Skyworks products.

“Skyworks” and the Skyworks Starburst logo are registered trademarks of Skyworks Solutions, Inc., in the United States and other countries. Third-party brands and names are for identification purposes only and are the property of their respective owners. Additional information, including relevant terms and conditions, posted at www.skyworksinc.com, are incorporated by reference.