

2.4GHZ CMOS WLAN / BLUETOOTH RFEIC WITH PA, LNA WITH BYPASS & SP3T SWITCH

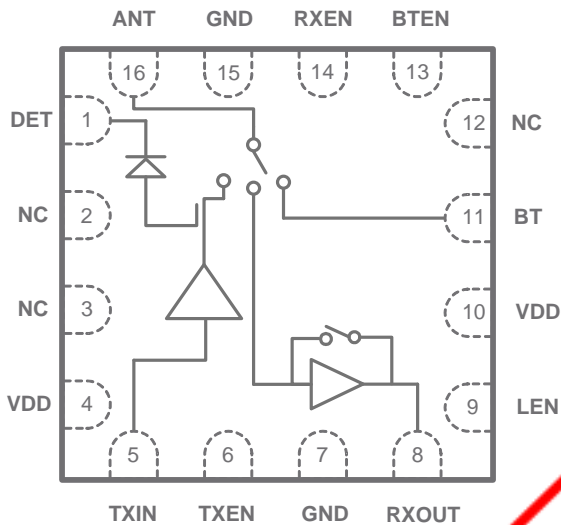

DESCRIPTION

The RFX8422 is a fully integrated, single-chip, single-die RFEIC (RF Front-end Integrated Circuit) which incorporates all the RF functionality needed for dual-mode WLAN, Bluetooth operations including simultaneous WLAN and Bluetooth receive capability.

The RFX8422 architecture integrates a high-efficiency high-linearity PA, a directional Coupler and output Power Detector, impedance matching networks, harmonic filters, a LNA with Bypass and an SP3T Antenna Switch all in a single CMOS device.

This RFEIC is designed to be used in combined 802.11b/g/n and Bluetooth applications operating in the 2.4GHz band, and can be powered directly from the battery.

Combining superior performance, ultra-low power consumption, small form factor, and low cost, RFX8422 is the perfect solution for mobile, handheld, and portable devices with integrated WLAN and Bluetooth. RFX8422 is assembled in ultra-compact 2.5 x 2.5 x 0.45 mm 16L QFN package, and requires minimal external components and PCB footprint.

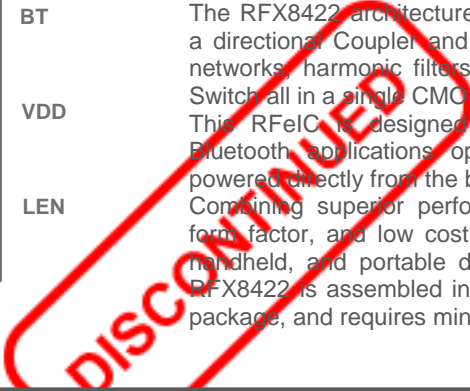

FEATURES

- Combines 802.11b/g/n and Bluetooth applications
- High linearity PA for 802.11 b/g/n WLAN
- Simultaneous WLAN and Bluetooth receive mode
- Low Noise Figure WLAN Receive LNA with Bypass for Near Range Operation
- Supports direct battery operation
- Built in directional coupler based output power detector
- ESD Protection Circuitry on All Ports
- DC decoupled RF Ports and VDD / RF Isolation
- 2.5mmx2.5mmx0.45mm Small Outline 16L QFN Package with Exposed Ground Pad

APPLICATIONS

- Smartphones, Feature Phones and MID's with WLAN/Bluetooth
- WLAN/Bluetooth Platforms Requiring Shared Antenna
- Laptop / Netbook / Smartbook with Embedded WiFi & Bluetooth
- Portable Platforms with Integrated 802.11b/g/n and Bluetooth

PACKAGE PIN OUT AND PIN DESCRIPTION

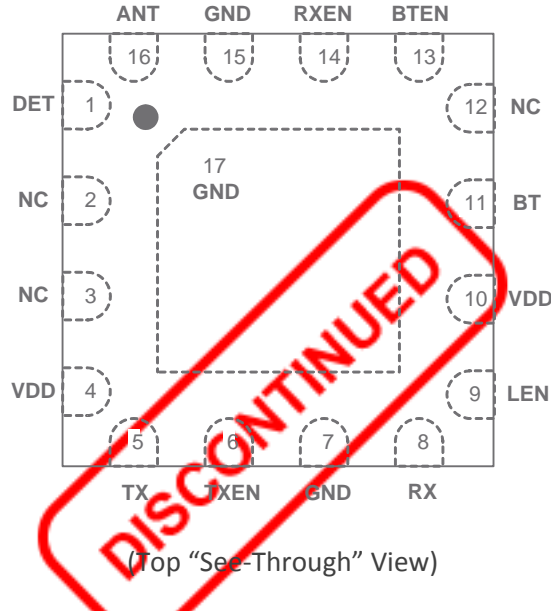

Pin Number	Pin Name	Description
1	DET	PA Power Detector Output
2, 3, 12	NC	Not Connected Internally. Can be Grounded or Left Open
4, 10	VDD	DC Voltage Supply
5	TXIN	WLAN TX Signal Port from the Transceiver: DC Shorted to GND
6	TXEN	CMOS Logic Control to Enable WLAN Transmit
7, 15, Paddle	GND	Ground – Must be Connected to Ground
8	RXOUT	WLAN RX Signal Port to the Transceiver: DC Shorted to GND
9	LEN	CMOS Logic Control to Enable LNA. Use to switch between the LNA and Bypass modes
11	BT	RF signal Port from/to the Bluetooth Transceiver: DC Shorted to GND
13	BTEN	CMOS Logic Control to Enable Bluetooth
14	RXEN	CMOS Logic Control to Enable WLAN Receive
16	ANT	RF Signal Port to/from the Antenna: DC Shorted to GND

ABSOLUTE MAXIMUM RATINGS

Parameters	Min.	Max.	Unit	Conditions
DC VDD Voltage Supply	0	5	V	All VDD Pins
DC Control Pin Voltage	0	3.6	V	All Control Pins
DC current consumption		300	mA	TXEN = 1
Tx RF Input Power		+5	dBm	
ANT RF Input Power		+10	dBm	
BT TX RF Input Power		+20	dBm	
Operating Temperature	-40	+85	°C	
Storage Ambient Temperature	-40	+125	°C	Appropriate care required according to JEDEC Standards

Note: Sustained operation at or above the Absolute Maximum Ratings for any single or combinations of the above parameters may result in permanent damage to the device and is not recommended.

All Maximum RF Input Power Ratings assume 50-Ohm terminal impedance.

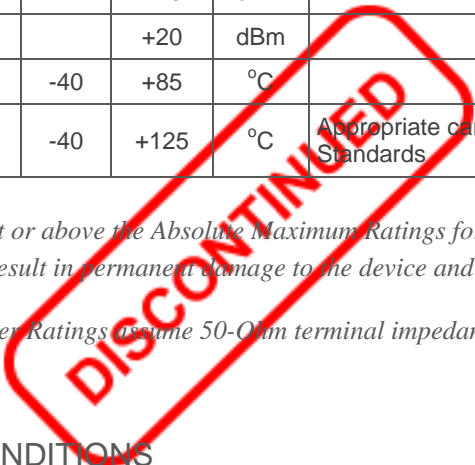

NORMAL OPERATING CONDITIONS

Parameters	Min	Typ	Max	Unit	Conditions
VDD Voltage Supply (Note 1)	2.9	3.6	4.8	V	
RF Port Impedance		50		Ω	Single-Ended
Control Voltage "High" (Note 2)	1.2		3.6	V	
Control Voltage "Low"	0		0.3	V	
Control Pin Current		0.1		μA	
Shutdown Current		6		μA	All Operation Modes
PA Turn On/Off Time		0.5	1	μs	
θ _{ja} (Note 3)		35		°C/W	
θ _{jc} Top (Note 4)		15		°C/W	
Antenna Switch Speed		0.5	1	μs	

Note 1: For normal operation of the RFX8422, VDD must be continuously applied to all VDD supply pins.

Note 2: If control voltage can exceed 1.8V, a 1KΩ series resistor is recommended for the application circuit on each control line.

Note 3: For operation above +85 °C, use the θ_{ja} as guidance for system design to assure the junction temperature will not exceed the maximum of +150 °C. This rating is dependent on proper thermal design.

Note 4: For reference only. Contact RFAxis for details regarding thermal testing and PCB thermal configuration.

TRANSMIT PATH CHARACTERISTICS (VDD=3.6V, T_a=+25 °C)

Parameters	Min	Typ	Max	Unit	Conditions
Operating Frequency	2.4		2.5	GHz	
Linear Output Power 1		+18		dBm	EVM<3%, 802.11g 64QAM/54Mbps
Linear Output Power 2		+17.5		dBm	EVM<2.8%, 802.11n MCS7 HT40
Linear Output Power 3		+21		dBm	802.11b 1Mbps CCK Mask Compliance
TX Small Signal Gain		26		dB	
Current Consumption		170		mA	P _{OUT} = +18dBm
Second Harmonics		-25		dBc	P _{OUT} = +21dBm (CW)
Third Harmonics		-40		dBc	P _{OUT} = +21dBm (CW)
Power Detector Voltage	200		1000	mV	P _{OUT} = +5 to +21 dBm, 10kΩ load
Directional Coupler Directivity		20		dB	
Input Return Loss		-10		dB	
Output Return		-10		dB	
Load VSWR for Stability (CW, Fix Pin for Pout=+20dBm with 50Ω Load)	4:1	6:1		N/A	All non-harmonically related spurs less than -43dBm/MHz
Load VSWR for Ruggedness (CW, Fix Pin for Pout=+20dBm with 50 Ω Load)	8:1	10:1		N/A	No Damage

RECEIVE PATH CHARACTERISTICS (VDD=3.6V, T_a=+25 °C)

Parameters	Min	Typ	Max	Unit	Conditions
Operating Frequency	2.4		2.5	GHz	
Small-Signal Gain (High Gain Mode)		11		dB	Between ANT and RX pins; RX/LEN = High
Noise Figure (High Gain Mode)		3		dB	At ANT pin
LNA 2 nd Harmonic		-30		dBc	At Input P1dB
LNA 3 rd Harmonic		-30		dBc	At Input P1dB
Insertion Loss (Bypass Mode)		10		dB	Between ANT and RX pins; LEN = Low
Insertion Loss (BT)		1.2		dB	Between ANT and BT pins

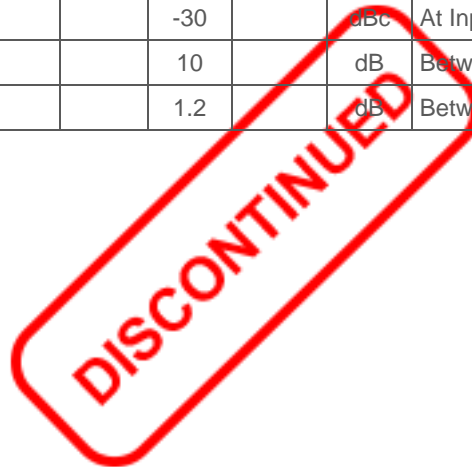
TRUTH TABLE

TXEN	BTEN	RXEN	LEN	Mode of Operating
0	0	0	0	Shutdown Mode
1	0	0	0	WLAN Transmit Mode
0	0	1	1	WLAN Receive. High Gain Mode
0	0	1	0	WLAN Receive. Bypass Mode
0	1	0	0	Bluetooth Transmit/Receive Mode

Note: "1" denotes high voltage state (> 1.2V) at Control Pins
 "0" denotes low voltage state (< 0.3V) at Control Pins
 1KΩ series resistor may be required for each control line

PACKAGE DIMENSIONS

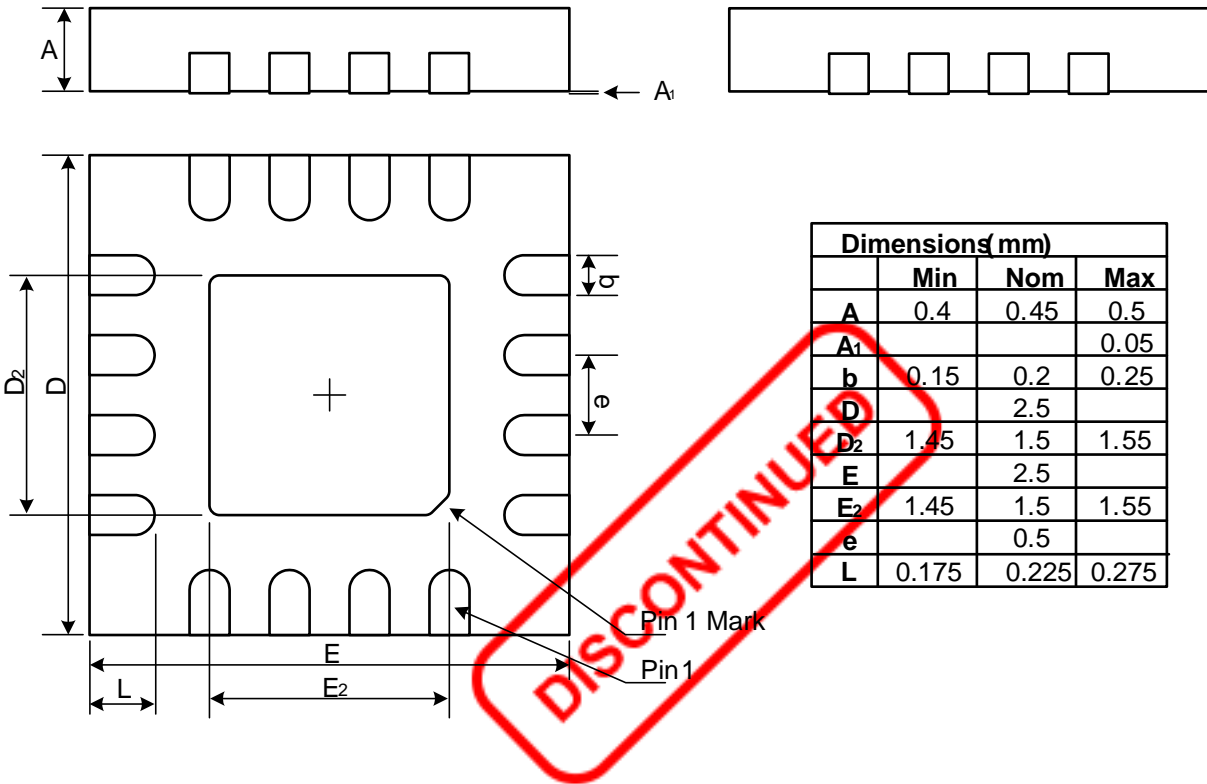

PCB LAND PATTERN

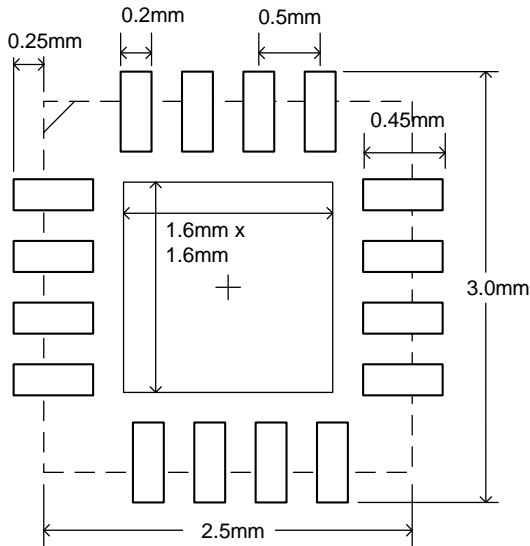

PACKAGE MARKING

