



SKY67183-396LF: 400 to 6000 MHz Broadband Low-Noise Amplifier

Applications

- FDD and TDD 4G LTE and 5G NR systems
- Active antenna array and massive MIMO systems
- Receive low-noise amplifier (LNA) for micro-cell, macro-cell, and small cell base stations
- Land mobile radios and military communications
- Low-noise broadband gain block and driver amplifiers
- Global Navigation Satellite System (GNSS) receivers
- Mobile satellite service (MSS) products

Features

- Typical noise figure 0.5 dB at 4200 MHz
- Temperature and process-stable active bias up to +115 °C
- Wide operating voltage range
- Low gain slope over operating band
- Excellent input return loss
- Integrated controller:
 - Stable amplifier bias
 - Temperature compensation
 - True logic level thresholds
 - Fast response time
- Excellent broadband flat gain performance
- Minimal BOM count
- Low current I_{DD} 56 mA @ 5 V
- Fast rise/fall time ENABLE function suitable for TDD applications
- Miniature 8-pin dual flat no lead (DFN) package, 2 x 2 mm, MSL1 @ 260 °C per JEDEC J-STD-020
- For RoHS and other product compliance information, see the [Skyworks Certificate of Conformance](#).

Description

The SKY67183-396LF is a wide-band LNA with high gain flatness and linearity.

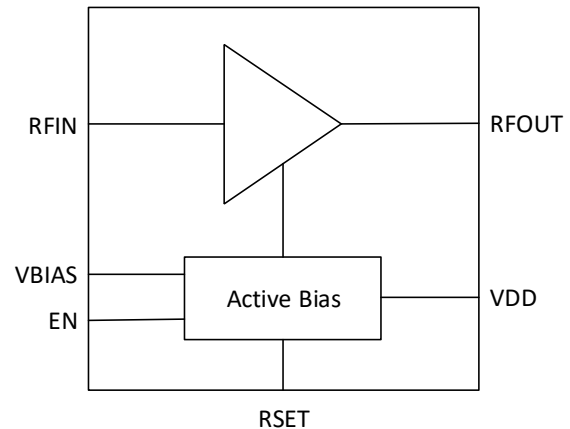

Figure 1. Functional Block Diagram

The compact DFN-packaged LNA is designed for FDD and TDD 4G LTE and 5G NR infrastructure systems operating from 400 to 6000 MHz.

The internal active bias circuitry provides stable performance over temperature and process variation.

A functional block diagram is shown in Figure 1. The pin configuration and package are shown in Figure 2. Signal pin assignments and functional pin descriptions are provided in Table 1.

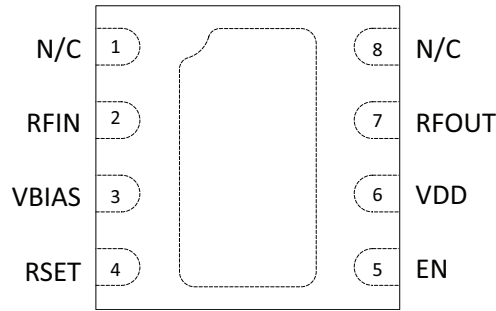

Figure 2. Pinout (Top View)

Table 1. Signal Descriptions

Pin	Name	Description	Pin	Name	Description
1	N/C	No connection (may be connected to ground with no change in performance)	5	EN	Enable voltage to LNA
2	RFIN	RF input (DC blocking capacitor required)	6	VDD	V _{DD} voltage to LNA
3	VBIAS	Bias voltage for input gate	7	RFOUT	RF output. DC blocking capacitor is required.
4	RSET	External resistor to set bias current	8	N/C	No connection (may be connected to ground with no change in performance)

Electrical Specifications

Table 2. Absolute Maximum Ratings¹

Parameter	Symbol	Minimum	Maximum	Units
Supply voltage	V _{DD}		5.5	V
LNA enable	EN	-0.5	2.8	V
Quiescent supply current	I _{DQ}		100	mA
RF input power (CW)	P _{IN}		+22	dBm
Storage temperature	T _{STG}	-65	+150	°C
Operating temperature	T _A	-40	+115	°C
Junction temperature	T _J		+150	°C
Electrostatic discharge: Charged Device Model (CDM), Class C3 Human Body Model (HBM), Class 1A	ESD		1000 250	V V

1. Exposure to maximum rating conditions for extended periods may reduce device reliability. There is no damage to device with only one parameter set at the limit and all other parameters set at or below their typical value as provided in Table 4.

ESD Handling: Industry-standard ESD handling precautions must be adhered to at all times to avoid damage to this device.

Table 3. Recommended Operating Conditions

Parameter	Symbol	Min	Typ	Max	Units
Supply voltage	V _{DD}	3.3	5.0	5.25	V
LNA enable: ON	EN	1.17	0	0.63	V
OFF			1.8	2.4	V

Table 4. Thermal Data¹

(V_{DD} = 5.0 V, enable = GND, T_A = +25 °C, P_{IN} = No RF, characteristic impedance [Z_O] = 50 Ω, unless otherwise noted)

Parameter	Symbol	Test Condition	Min	Typ	Max	Units
Thermal resistance	Θ _{JC}			79.8		°C/W
Channel temperature @ +115 °C reference (package heat slug)	T _J	V _{DD} = 5.0 V, I _{DQ} = 61 mA, no RF applied, dissipated power = 0.31 W		139		°C

1. Performance is assured only under the conditions listed in this table. Modes are established as indicated in the operating modes truth table. Minimum and maximum values are verified in production by measurement at 25 °C under typical operating conditions.

Table 5. 4200 to 4900 MHz with Optimized BOM in Table 10¹

(V_{DD} = 5.0 V, Enable = GND, T_A = +25 °C, P_{IN} = -20 dBm, characteristic impedance [Z_O] = 50 Ω, unless otherwise noted)

Parameter	Symbol	Test Condition	Min	Typ	Max	Units
RF Specifications						
Noise figure	NF	@ 4200 MHz @ 4500 MHz @ 4900 MHz		0.5 0.5 0.6	1.0 1.0 1.1	dB dB dB
Small signal gain	S21	@ 4200 MHz @ 4500 MHz @ 4900 MHz	16.5	18.2 18.2 17.7		dB dB dB
Input return loss	S11	@ 4200 MHz @ 4500 MHz @ 4900 MHz	12	16.1 32.8 21.9		dB dB dB
Output return loss	S22	@ 4200 MHz @ 4500 MHz @ 4900 MHz	10	11.2 23.2 14.9		dB dB dB
Reverse isolation	S12	@ 4200 MHz @ 4500 MHz @ 4900 MHz	26	32 32 32		dB dB dB
Third order output intercept (-20 dBm input/1 MHz tone)	OIP3	@ 4200 MHz @ 4500 MHz @ 4900 MHz	+27	+29 +29 +28.5		dBm dBm dBm
1 dB output compression point	OP1dB	@ 4200 MHz @ 4500 MHz @ 4900 MHz	+16	+20 +19 +20		dBm dBm dBm
DC Specifications						
Supply voltage	V _{DD}			5.0		V
Quiescent current	I _{DD}		45	56	67	mA
Settling time 0.3 dB2 Settling time 0.1 dB3	TS1 TS2	@ 4500 MHz		0.3 0.31	0.9 0.9	us us

1. Performance is assured only under the conditions listed in this table.

Typical Performance Characteristics, 4200 to 4900 MHz

$V_{DD} = 5\text{ V}$, $P_{IN} = -20\text{ dBm}$, characteristic impedance $[Z_0] = 50\ \Omega$, unless otherwise noted

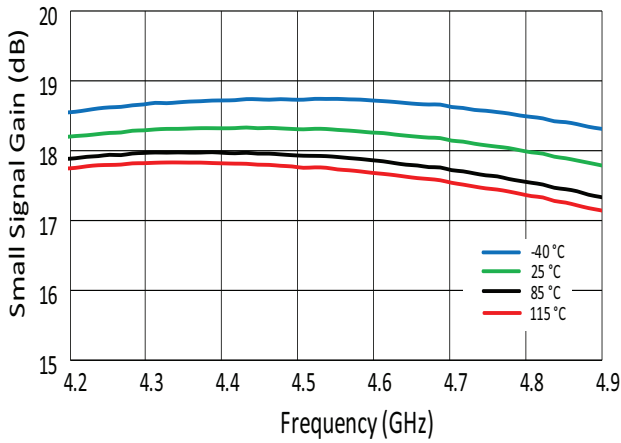

Figure 3. Small Signal Gain vs. Frequency

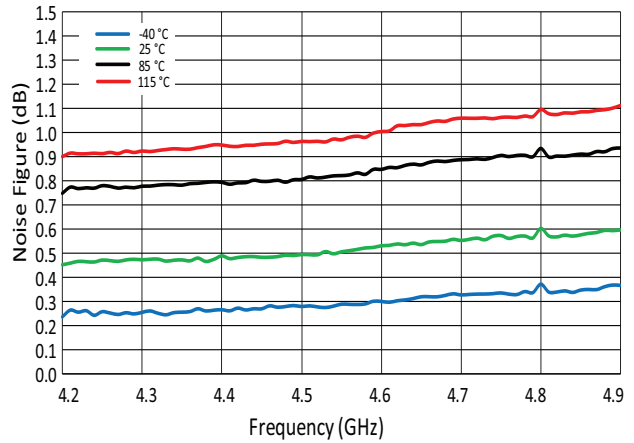

Figure 4. Noise Figure vs. Frequency

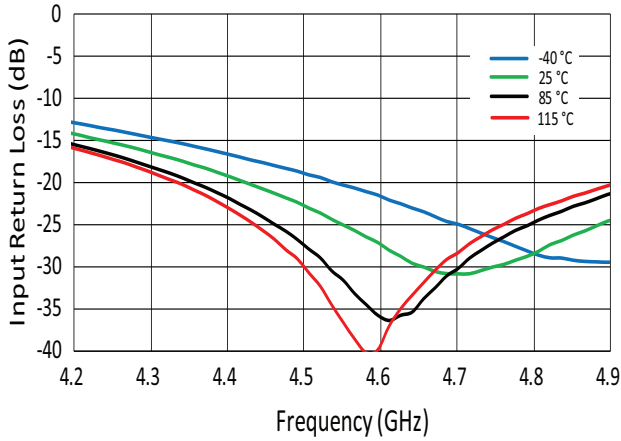

Figure 5. Input Return Loss vs. Frequency

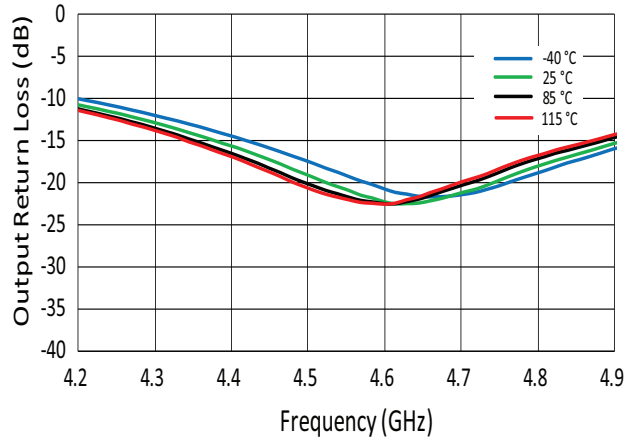

Figure 6. Output Return Loss vs. Frequency

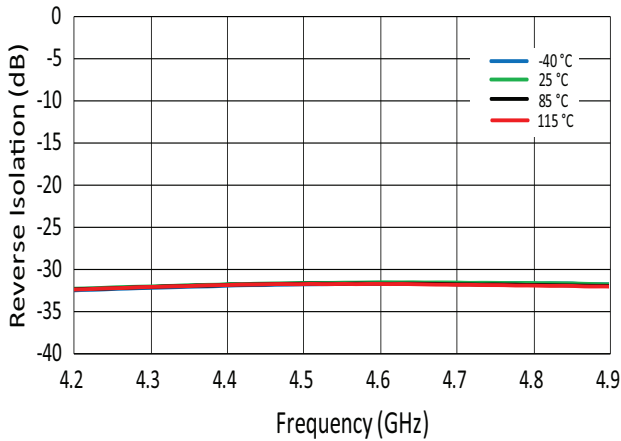

Figure 7. Reverse Isolation vs. Frequency

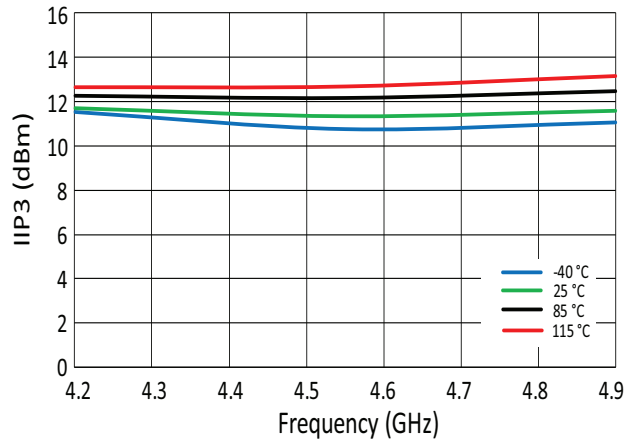

Figure 8. IIP3 vs. Frequency

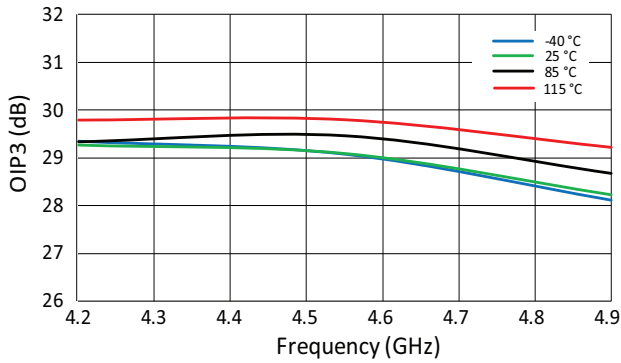

Figure 9. OIP3 vs. Frequency

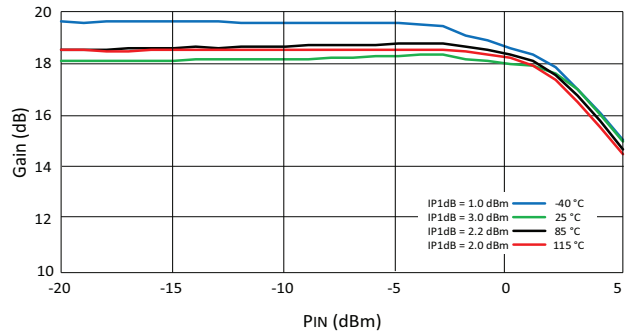

Figure 10. Gain vs. P_{IN}

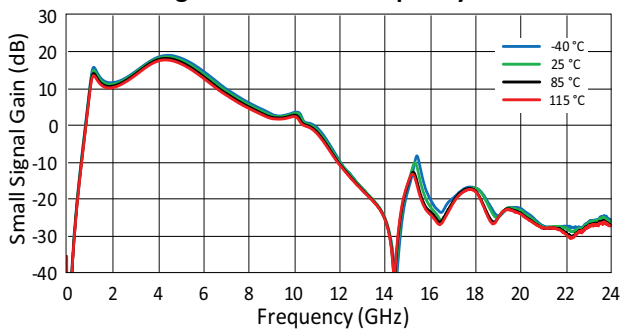

Figure 11. Small Signal Gain vs. Frequency

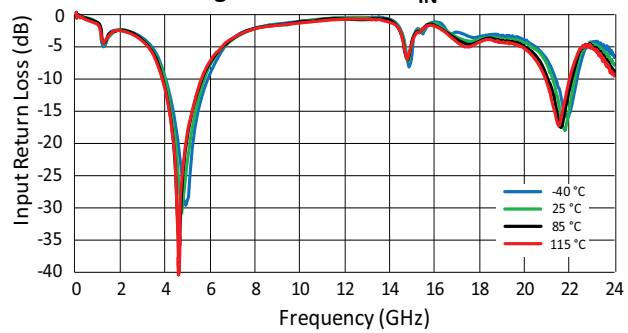

Figure 12. Input Return Loss vs. Frequency

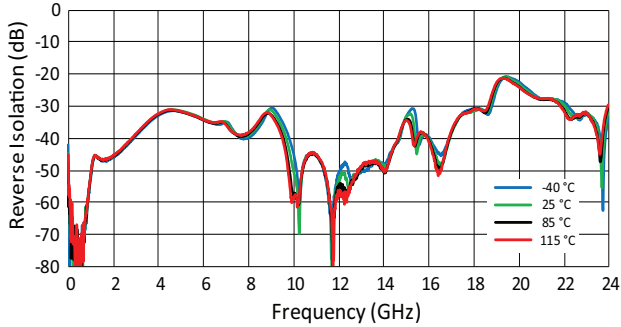

Figure 13. Reverse Isolation vs. Frequency

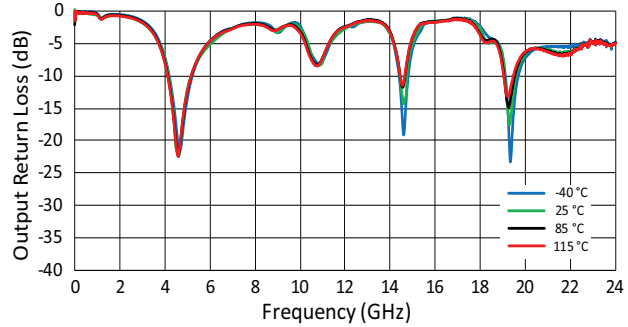

Figure 14. Output Return Loss vs. Frequency

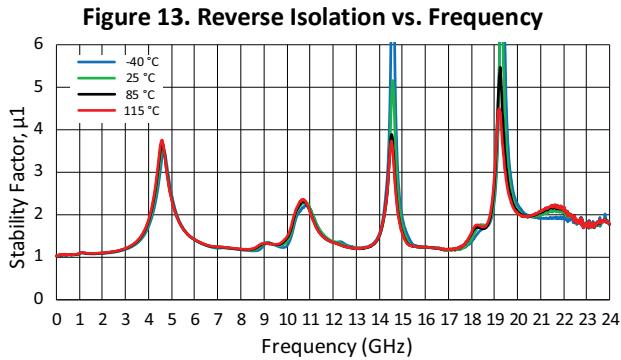

Figure 15. Stability Factor, μ_1 vs. Frequency

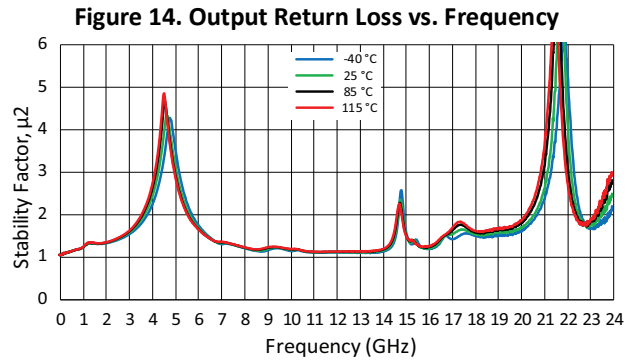

Figure 16. Stability Factor, μ_2 vs. Frequency

Table 6. 3300 to 3800 MHz with Optimized BOM, Table 11¹

(V_{DD} = 5.0 V, Enable = GND, T_A = +25 °C, P_{IN} = -20 dBm, characteristic impedance [Z_O] = 50 Ω, unless otherwise noted)

Parameter	Symbol	Test Condition	Min	Typ	Max	Units
RF Specifications						
Noise figure	NF	@ 3300 MHz @ 3400 MHz @ 3600 MHz @ 3800 MHz		0.42 0.42 0.43 0.49	0.72 0.72 0.72 0.80	dB dB dB dB
Gain	S ₂₁	@ 3300 MHz @ 3400 MHz @ 3600 MHz @ 3800 MHz	16.9 17.0 17.0 16.9	19.1 19.1 19.1 18.9		dB dB dB
Input return loss	S ₁₁	@ 3300 MHz @ 3400 MHz @ 3600 MHz @ 3800 MHz	9.6 11.2 15.4 18.3	12.3 14.4 20.6 31.9		dB dB dB dB
Output return loss	S ₂₂	@ 3300 MHz @ 3400 MHz @ 3600 MHz @ 3800 MHz	6.5 7.7 10.1 13.1	9.8 11.8 16.4 19.0		dB dB dB dB
Reverse isolation	S ₁₂	@ 3300 MHz @ 3400 MHz @ 3600 MHz @ 3800 MHz	29.6 29.4 29.0 28.8	33.1 32.8 32.4 32.1		dB dB dB dB
Third order output intercept point	OIP3	PIN = -20 dBm, Δ Tone = 1 MHz: @ 3300 MHz @ 3400 MHz @ 3600 MHz @ 3800 MHz	27.0 27.1 25.8 28.9	30.3 30.3 28.9 34.7		dBm dBm dBm dBm
1 dB output compression point	OP1dB	@ 3300 MHz @ 3400 MHz @ 3600 MHz @ 3800 MHz	18.1 18.0 17.9 18.4	20.3 20.2 20.1 20.6		dBm dBm dBm dBm
DC Specifications						
Supply voltage	V _{DD}			5.0		V
Quiescent current	I _{DD}		45	56	67	mA
Settling time 0.3 dB ² Settling time 0.1 dB ³	TS1 TS2	@ 3600 MHz		0.28 0.29		us us

1. Verified by characterization.
2. Settling time 0.3 dB is measured from the time the LNA enable reaches 50% of LNA enable "on" level to the time at which the RF output power achieves within 0.3 dB of the average steady-state "on" level.
3. Settling time 0.1 dB is measured from the time the LNA enable reaches 50% of LNA enable "on" level to the time at which the RF output power achieves within 0.1 dB of the average steady-state "on" level.

Typical Performance Characteristics, 3300 to 3800 MHz

$V_{DD} = 5\text{ V}$, $T_A = +25\text{ }^\circ\text{C}$, $P_{IN} = -20\text{ dBm}$, characteristic impedance $[Z_0] = 50\ \Omega$ unless otherwise noted

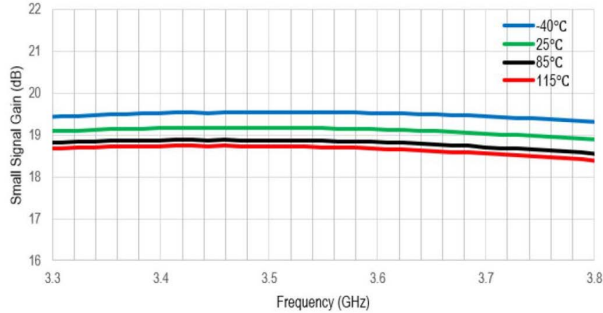

Figure 17. Small Signal Gain vs. Frequency

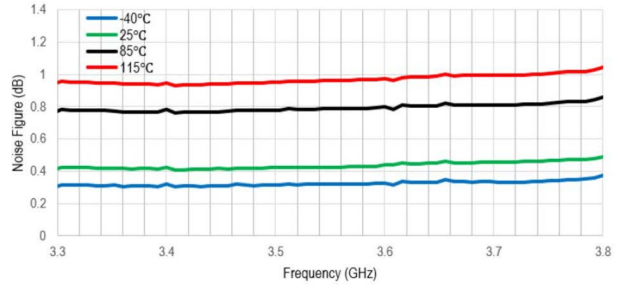

Figure 18. Noise Figure vs. Frequency

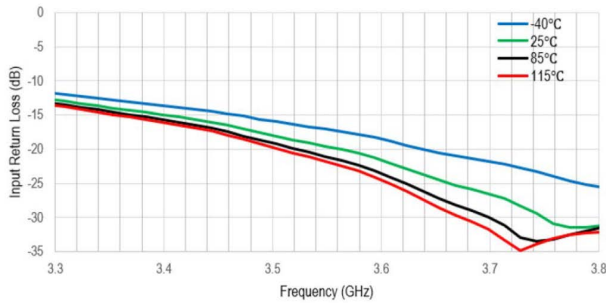

Figure 19. Input Return Loss vs. Frequency

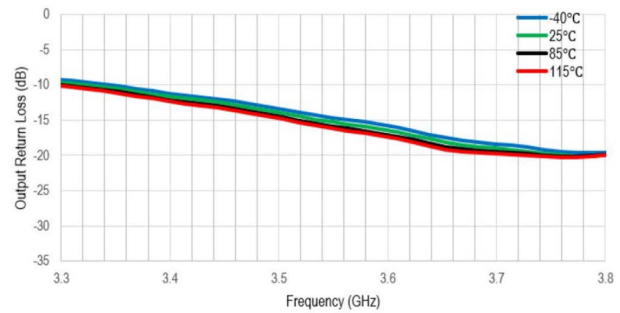

Figure 20. Output Return Loss vs. Frequency

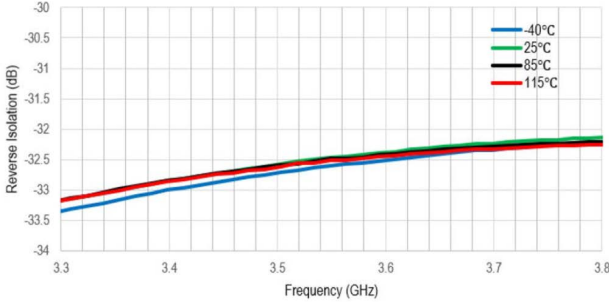

Figure 21. Reverse Isolation vs. Frequency

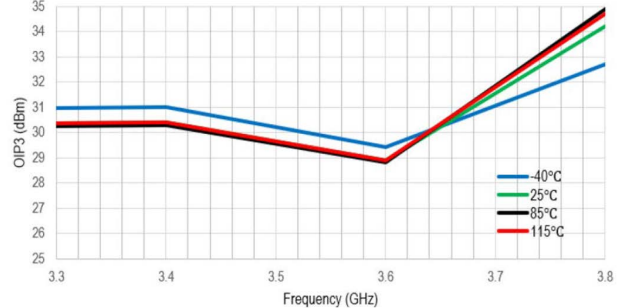

Figure 22. Output Return Loss vs. Frequency

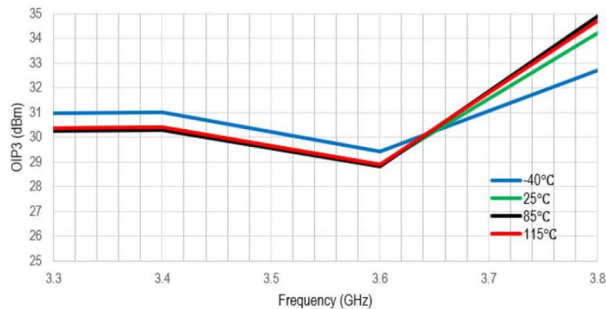

Figure 23. OIP3 vs. Frequency

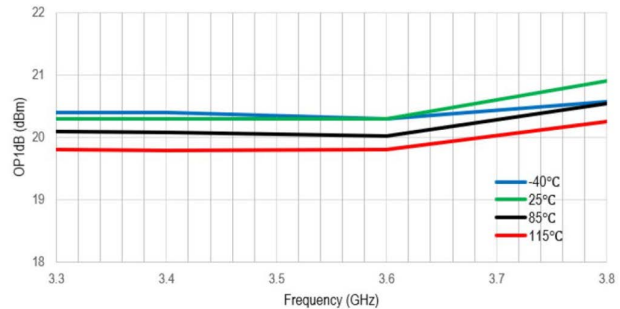

Figure 24. OP1dB vs. Frequency

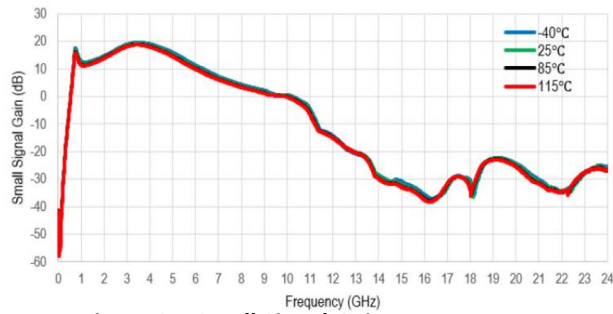

Figure 25. Small Signal Gain vs. Frequency

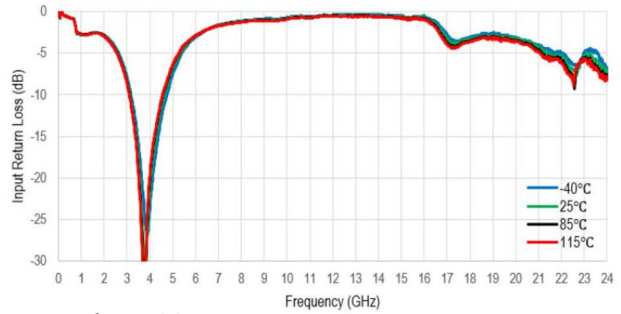

Figure 26. Input Return Loss vs. Frequency

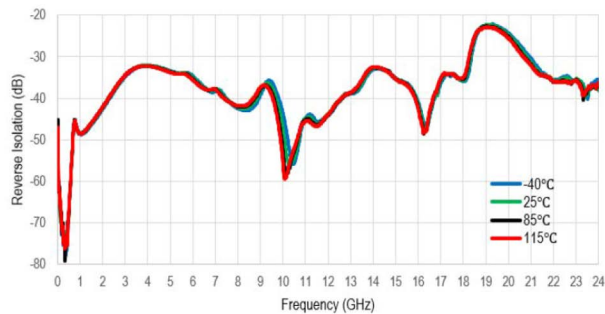

Figure 27. Reverse Isolation vs. Frequency

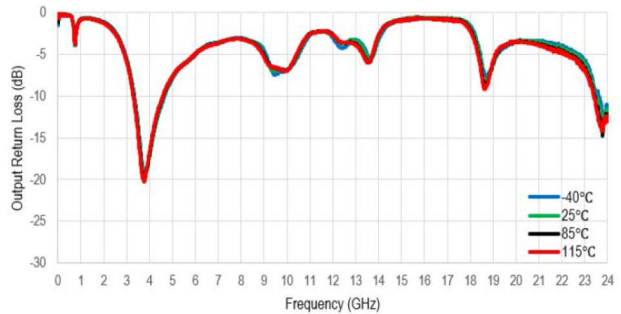

Figure 28. Output Return Loss vs. Frequency

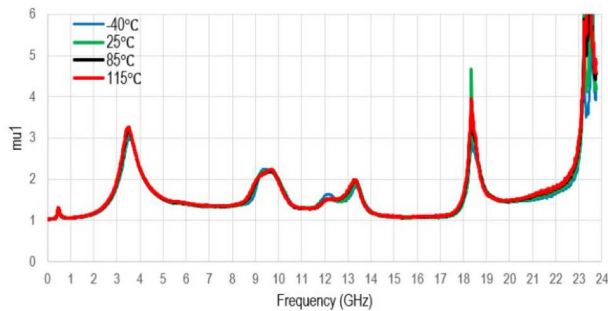

Figure 29. Stability Factor, μ_1 vs. Frequency

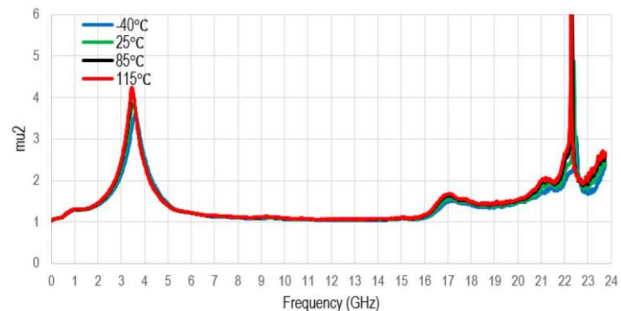

Figure 30. Stability Factor μ_2 vs. Frequency

Table 7. 2300 to 2700 MHz with Optimized BOM in Table 12¹

(V_{DD} = 5.0 V, Enable = GND, T_A = +25 °C, P_{IN} = -20 dBm, characteristic impedance [Z_O] = 50 Ω, unless otherwise noted)

Parameter	Symbol	Test Condition	Min	Typ	Max	Units
RF Specifications						
Noise figure	NF	@ 2300 MHz @ 2500 MHz @ 2700 MHz		0.36 0.41 0.43	0.75 0.75 0.85	dB
Gain	S21	@ 2300 MHz @ 2500 MHz @ 2700 MHz	20 20 19	21.7 21.4 20.9		dB
Input return loss	S11	@ 2300 MHz @ 2500 MHz @ 2700 MHz	9 10 10	13 16.4 18.7		dB
Output return loss	S22	@ 2300 MHz @ 2500 MHz @ 2700 MHz	7 9 9	11.2 13.5 12.6		dB
Reverse isolation	S12	@ 2300 MHz @ 2500 MHz @ 2700 MHz		33.8 33.4 33.2		dB
Third order output intercept point	OIP3	PIN = -20 dBm, Δ tone = 1 MHz: @ 2300 MHz @ 2500 MHz @ 2700 MHz	29 29 29	+32.2 +32.7 +33.4		dBm
1 dB output compression point	OP1dB	@ 2300 MHz @ 2500 MHz @ 2700 MHz	18 20 20	+19.5 +22 +22.1		dBm
DC Specifications						
Supply voltage	V _{DD}			5.0		V
Quiescent current	I _{DD}			56		mA
Settling time 0.3 dB ² Settling time 0.1 dB ³	TS1 TS2	@ 2500 MHz		0.3 0.33		μs

1. Verified by characterization.
2. Settling time 0.3 dB is measured from the time the LNA enable reaches 50% of LNA enable “on” level to the time at which the RF output power achieves within 0.3 dB of the average steady-state “on” level.
3. Settling time 0.1 dB is measured from the time the LNA enable reaches 50% of LNA enable “on” level to the time at which the RF output power achieves within 0.1 dB of the average steady-state “on” level.

Typical Performance Characteristics, 2300 to 2700 MHz

$V_{DD} = 5\text{ V}$, $T_A = +25\text{ }^\circ\text{C}$, $P_{IN} = -20\text{ dBm}$, characteristic impedance (Z_0) = $50\ \Omega$, unless otherwise noted

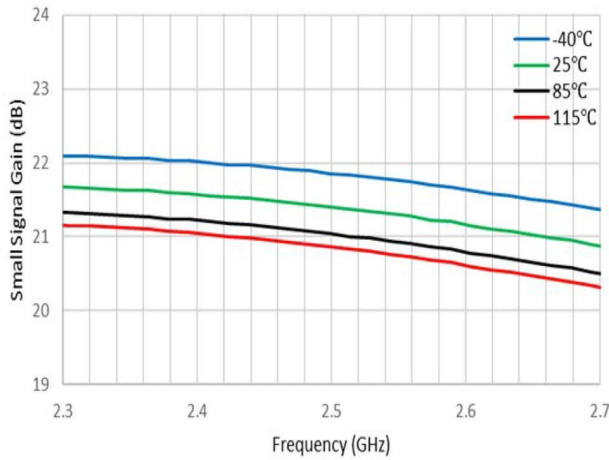

Figure 31. Small Signal Gain vs. Frequency

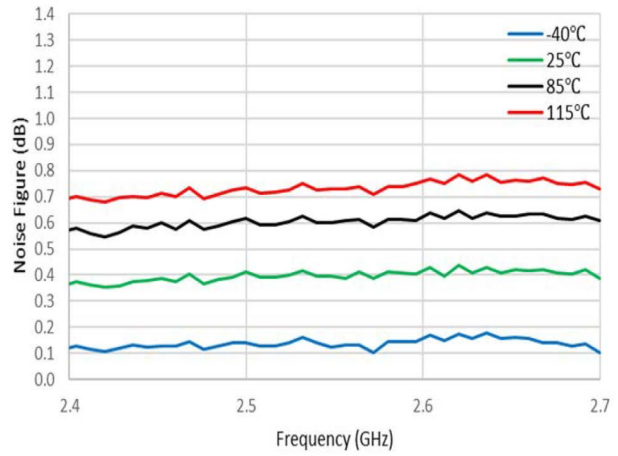

Figure 32. Noise Figure vs. Frequency

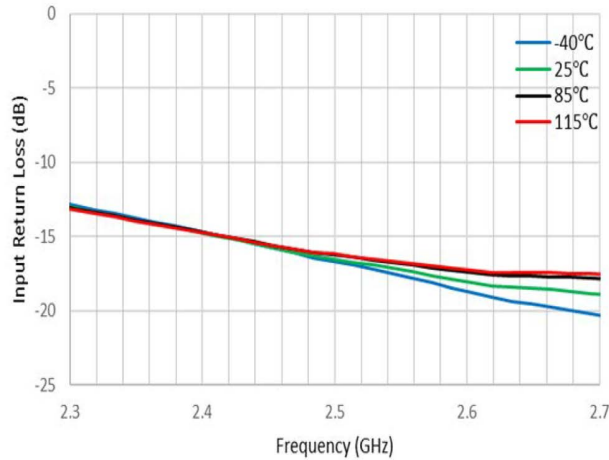

Figure 33. Input Return Loss vs. Frequency

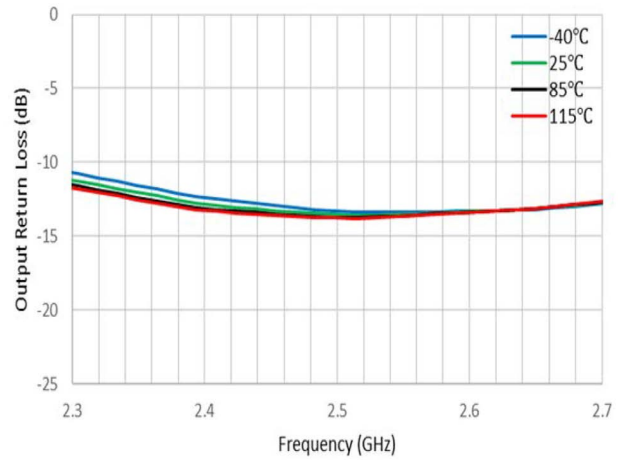

Figure 34. Output Return Loss vs. Frequency

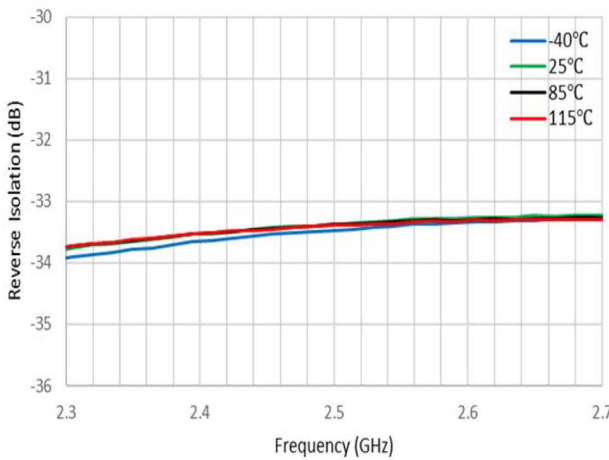

Figure 35. Reverse Isolation vs. Frequency

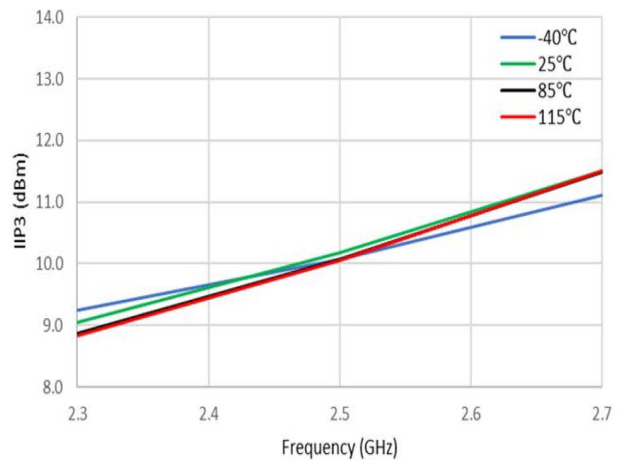

Figure 36. IIP3 vs. Frequency

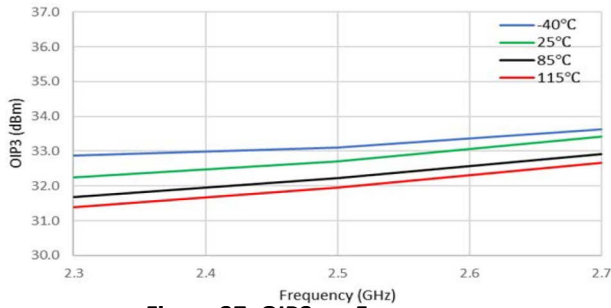

Figure 37. OIP3 vs. Frequency

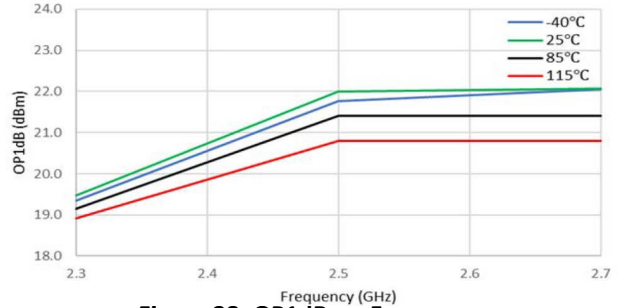

Figure 38. OP1dB vs. Frequency

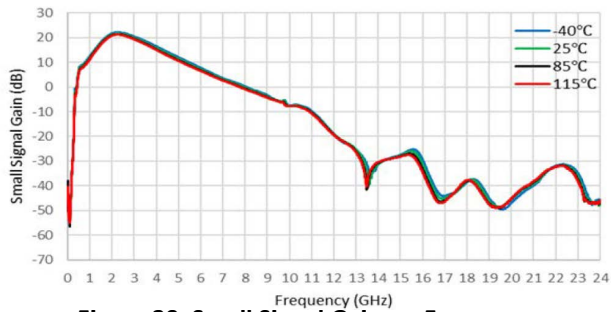

Figure 39. Small Signal Gain vs. Frequency

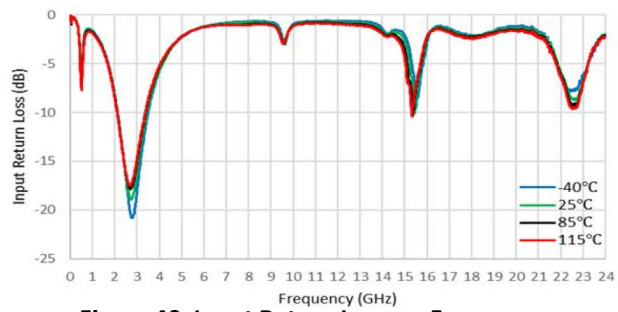

Figure 40. Input Return Loss vs. Frequency

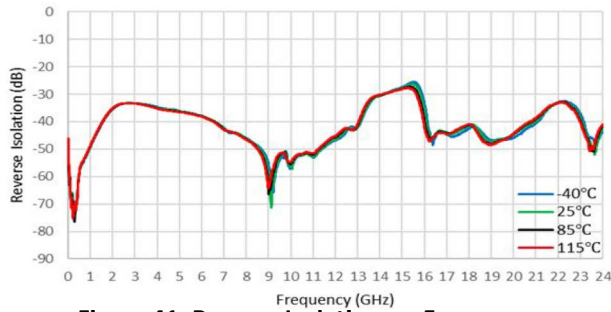

Figure 41. Reverse Isolation vs. Frequency

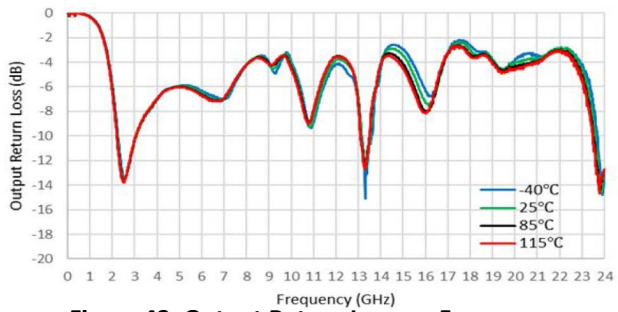

Figure 42. Output Return Loss vs. Frequency

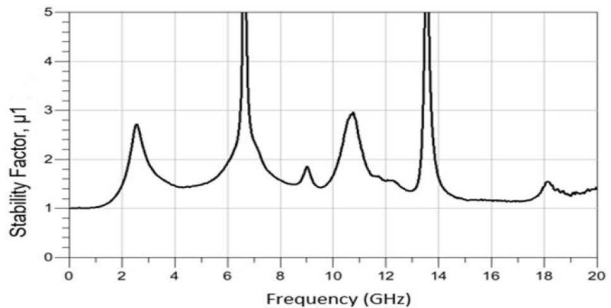

Figure 43. Stability Factor, μ_1 vs. Frequency at $-40\text{ }^\circ\text{C}$

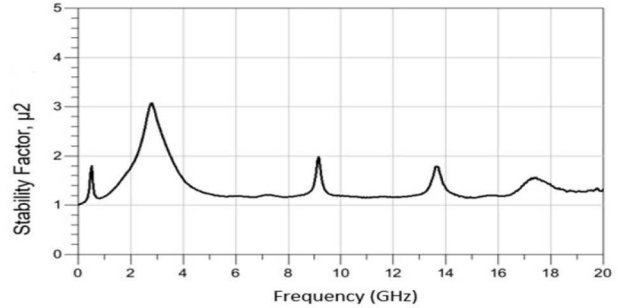

Figure 44. Stability Factor, μ_2 vs. Frequency at $-40\text{ }^\circ\text{C}$

Table 8. 1700 to 2200 MHz with Optimized BOM in Table 13¹

(V_{DD} = 5.0 V, enable = GND, T_A = +25 °C, PIN = -20 dBm, characteristic impedance [Z_O] = 50 Ω, unless otherwise noted)

Parameter	Symbol	Test Condition	Min	Typ	Max	Units
RF Specifications						
Noise figure	NF	@ 1700 MHz @ 1950 MHz @ 2200 MHz		0.34 0.38 0.41	0.75 0.75 0.85	dB dB dB
Gain	S21	@ 1700 MHz @ 1950 MHz @ 2200 MHz	21.5 21 19.5	23.2 22.7 21.5		dB dB dB
Input return loss	S11	@ 1700 MHz @ 1950 MHz @ 2200 MHz	10 10 10	15.7 26.2 14.8		dB dB dB
Output return loss	S22	@ 1700 MHz @ 1950 MHz @ 2200 MHz	7 10 10	9.7 25.2 20.6		dB dB dB
Reverse isolation	S12	@ 1700 MHz @ 1950 MHz @ 2200 MHz		34.4 34.2 34.6		dB dB dB
Third order output intercept point	OIP3	PIN = -20 dBm, Δ Tone = 1 MHz: @ 1700 MHz @ 1950 MHz @ 2200 MHz	28 28 28	+31.8 +32.2 +32.5		dBm dBm dBm
1 dB output compression point	OP1dB	@ 1700 MHz @ 1950 MHz @ 2200 MHz	17.5 18.0 19.0	+19.1 +20.2 +21.1		dBm dBm dBm
DC Specifications						
Supply voltage	V _{DD}			5		V
Quiescent current	IDD			56		mA
Settling time 0.3 dB ² Settling time 0.1 dB ³	TS1 TS2	@ 1950 MHz		0.3 0.33		us us

1. Verified by characterization.
2. Settling time 0.3 dB is measured from the time the LNA enable reaches 50% of LNA enable “on” level to the time at which the RF output power achieves within 0.3 dB of the average steady-state “on” level.
3. Settling time 0.1 dB is measured from the time the LNA enable reaches 50% of LNA enable “on” level to the time at which the RF output power achieves within 0.1 dB of the average steady-state “on” level.

Typical Performance Characteristics, 1700 to 2200 MHz

$V_{DD} = 5\text{ V}$, $P_{IN} = -20\text{ dBm}$, Characteristic Impedance [Z_0] = $50\ \Omega$, unless otherwise noted

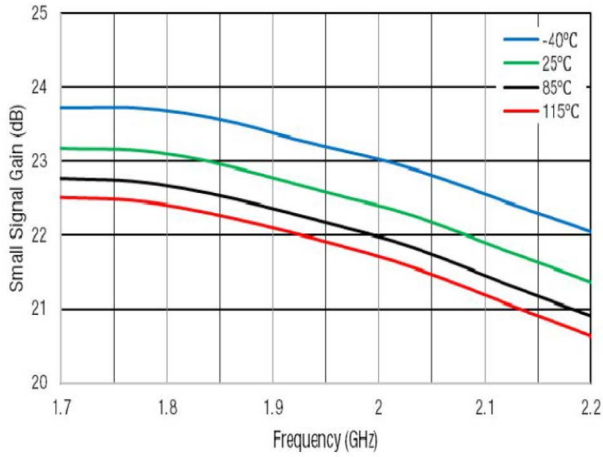

Figure 45. Small Signal Gain vs. Frequency

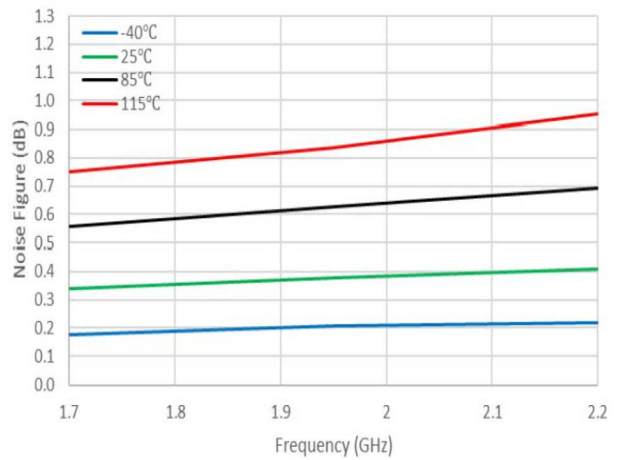

Figure 46. Noise Figure vs. Frequency

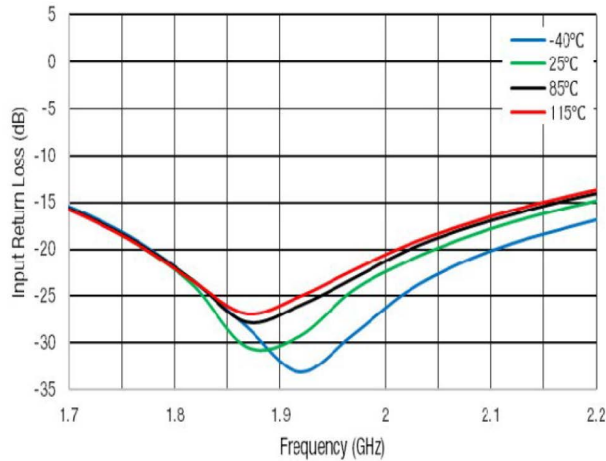

Figure 47. Input Return Loss vs. Frequency

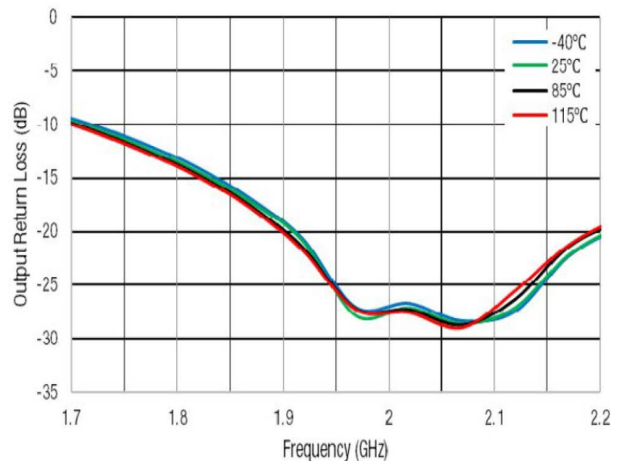

Figure 48. Output Return Loss vs. Frequency

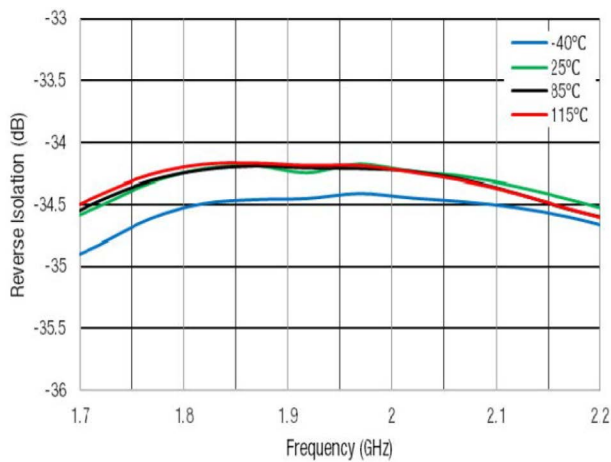

Figure 49. Reverse Isolation vs. Frequency

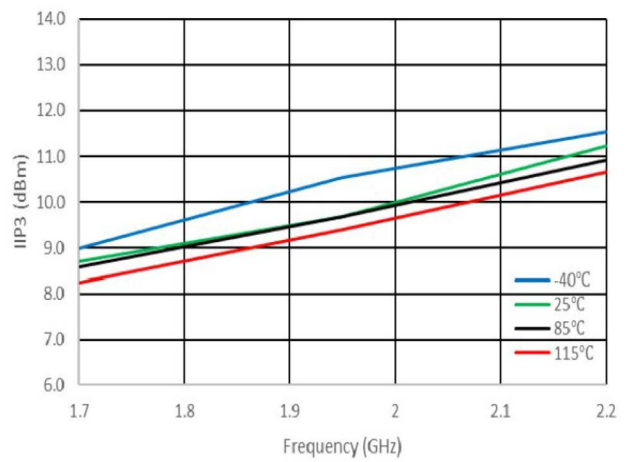

Figure 50. IIP3 vs. Frequency

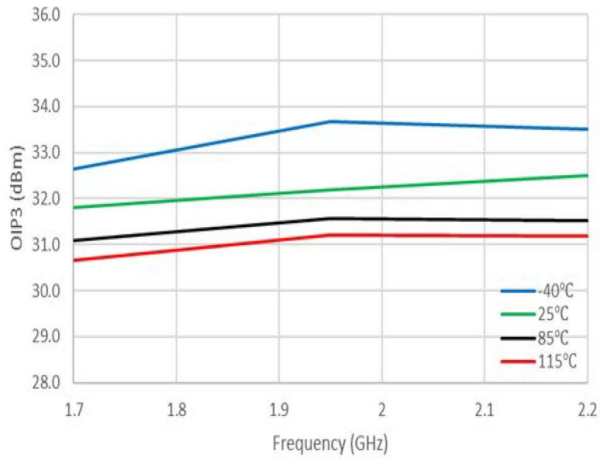

Figure 51. OIP3 vs. Frequency

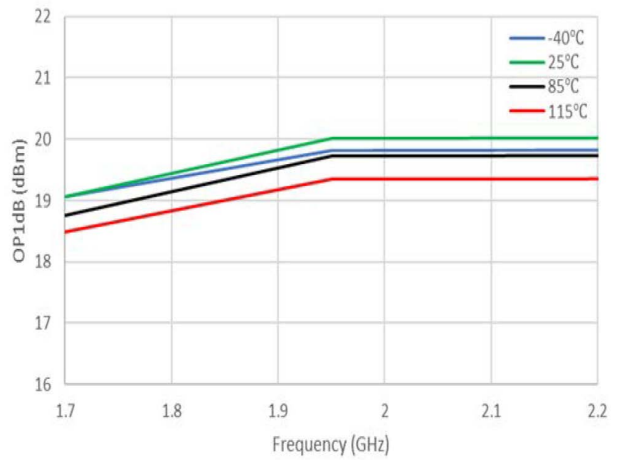

Figure 52. OP1dB vs. Frequency

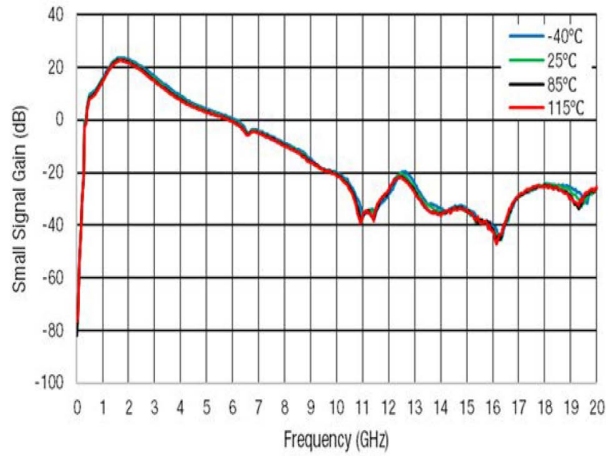

Figure 53. Small Signal Gain vs. Frequency

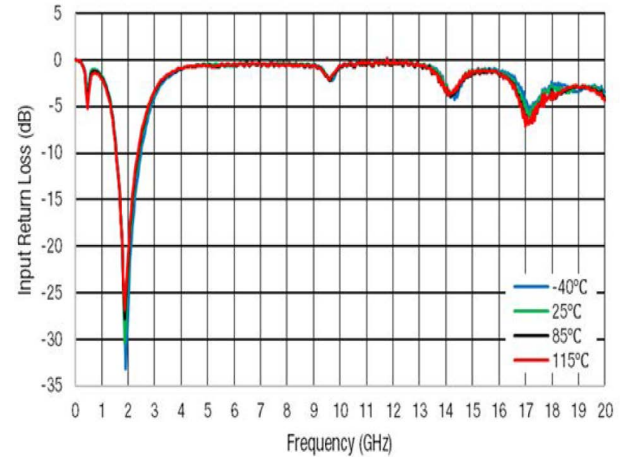

Figure 54. Input Return Loss vs. Frequency

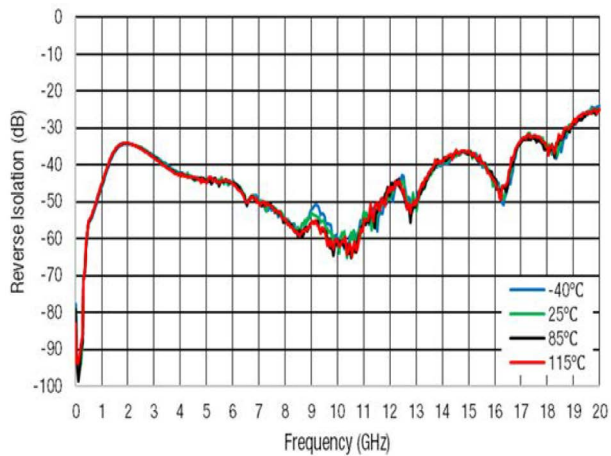

Figure 55. Reverse Isolation vs. Frequency

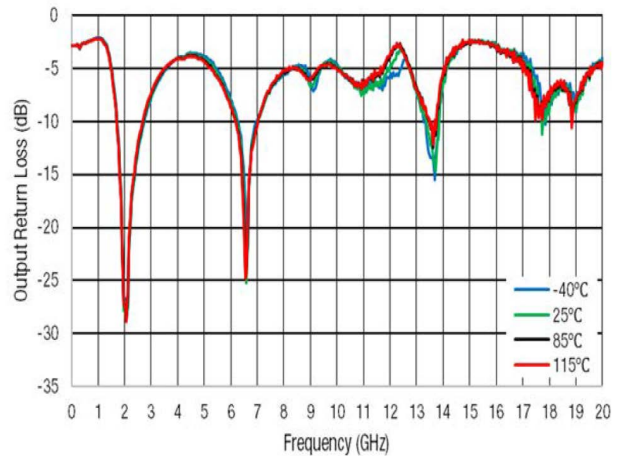

Figure 56. Output Return Loss vs. Frequency

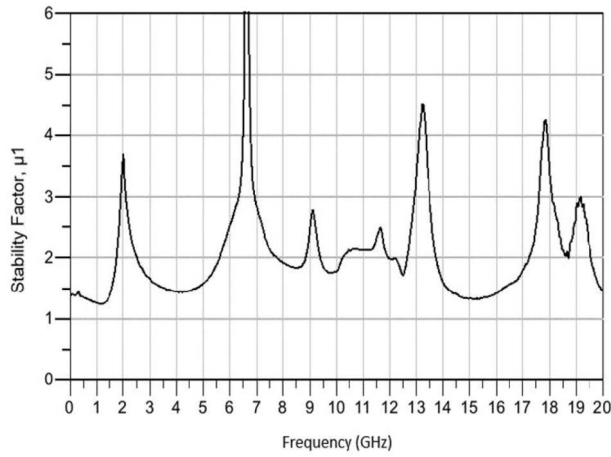

Figure 57. Stability Factor, μ_1 vs. Frequency at $-40\text{ }^\circ\text{C}$

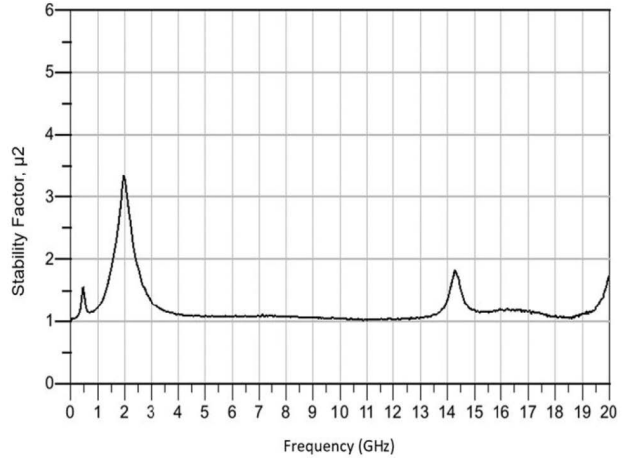

Figure 58. Stability Factor, μ_2 vs. Frequency at $-40\text{ }^\circ\text{C}$

Table 9. 1100 to 1650 MHz with Optimized BOM in Table 14¹

(V_{DD} = 5.0 V, enable = GND, T_A = +25 °C, P_{IN} = -20 dBm, characteristic impedance [Z_O] = 50 Ω, unless otherwise noted)

Parameter	Symbol	Test Condition	Min	Typ	Max	Units
RF Specifications						
Noise figure	NF	@ 1164 MHz @ 1300 MHz @ 1559 MHz @ 1610 MHz		0.34 0.33 0.32 0.31	0.46 0.44 0.43 0.42	dB
Gain	S ₂₁	@ 1164 MHz @ 1300 MHz @ 1559 MHz @ 1610 MHz	22.6 22.2 20.9 20.6	25.2 24.8 23.4 23.1		dB
Input return loss	S ₁₁	@ 1164 MHz @ 1300 MHz @ 1559 MHz @ 1610 MHz	14 24 12 11	18.3 37.1 15.9 14.5		dB
Output return loss	S ₂₂	@ 1164 MHz @ 1300 MHz @ 1559 MHz @ 1610 MHz	8 12 18 19	10.7 15.2 23.7 25.1		dB
Reverse isolation	S ₁₂	@ 1164 MHz @ 1300 MHz @ 1559 MHz @ 1610 MHz	31 31 31 31	34.7 34.6 34.8 34.9		dB
Third order output intercept point	OIP3	PIN = -20 dBm, Δ Tone = 1 MHz: @ 1164 MHz @ 1300 MHz @ 1559 MHz @ 1610 MHz	26.4 27.4 27.5 27.5	29.6 30.7 30.8 30.7		dBm
1 dB output compression point	OP1dB	@ 1164 MHz @ 1300 MHz @ 1559 MHz @ 1610 MHz	17.0 17.7 18.1 18.4	19.0 19.8 20.2 20.5		dBm
DC Specifications						
Supply voltage	V _{DD}			5		V
Quiescent current	I _{DD}			56		mA
Settling time 0.3 dB ² Settling time 0.1 dB ³	T _{S1} T _{S2}	@ 1300 MHz		0.3 0.33		μs

1. Verified by characterization.
2. Settling time 0.3 dB is measured from the time the LNA enable reaches 50% of LNA enable “on” level to the time at which the RF output power achieves within 0.3 dB of the average steady-state “on” level.
3. Settling time 0.1 dB is measured from the time the LNA enable reaches 50% of LNA enable “on” level to the time at which the RF output power achieves within 0.1 dB of the average steady-state “on” level.

Typical Performance Characteristics, 1100 to 1650 MHz

$V_{DD} = 5\text{ V}$, $T_A = +25\text{ }^\circ\text{C}$, $P_{IN} = -20\text{ dBm}$, characteristic impedance (Z_0) = $50\ \Omega$, unless otherwise noted

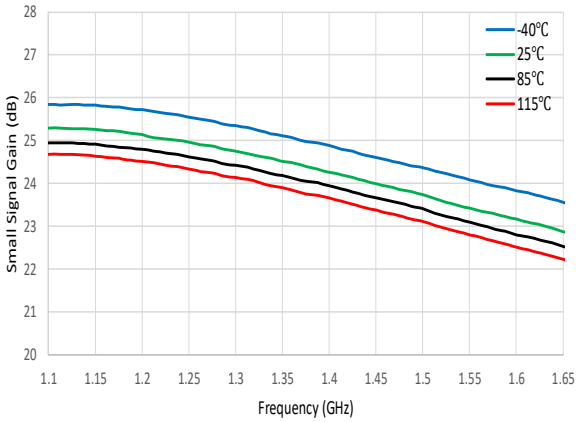

Figure 59. Small Signal Gain vs. Frequency

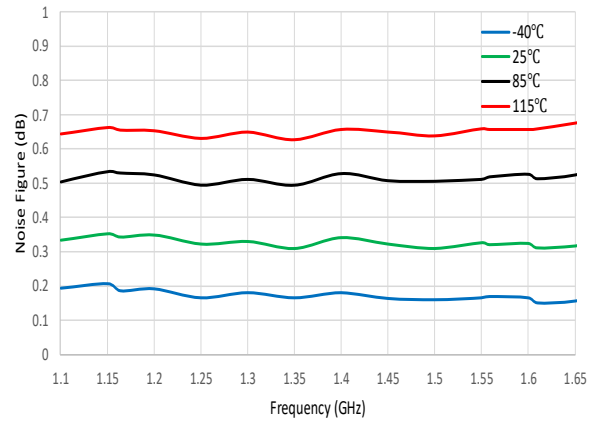

Figure 60. Noise Figure vs. Frequency

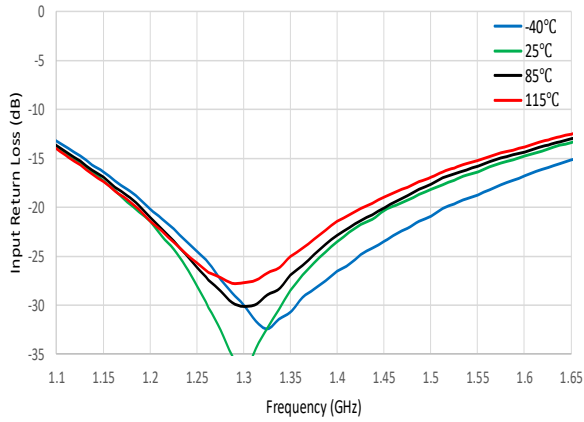

Figure 61. Input Return Loss vs. Frequency

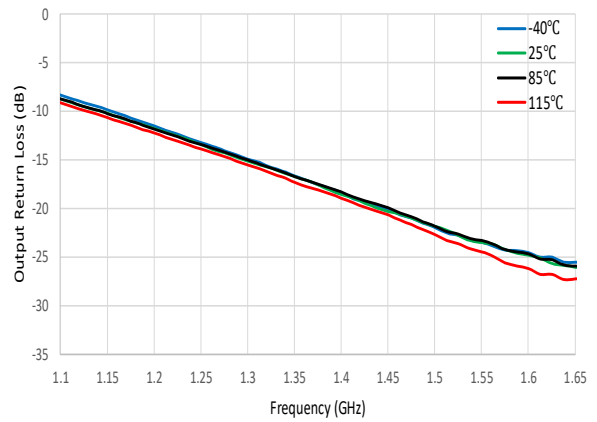

Figure 62. Output Return Loss vs. Frequency

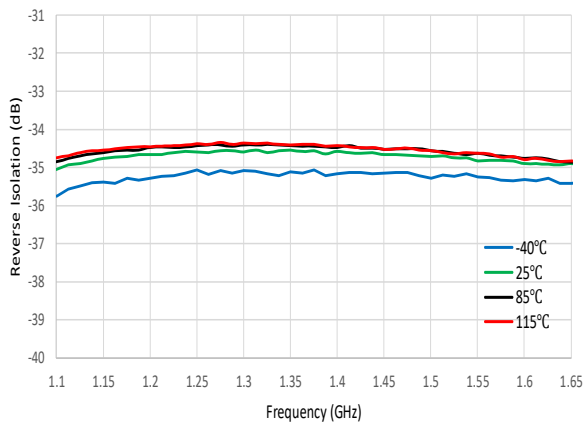

Figure 63. Reverse Isolation vs. Frequency

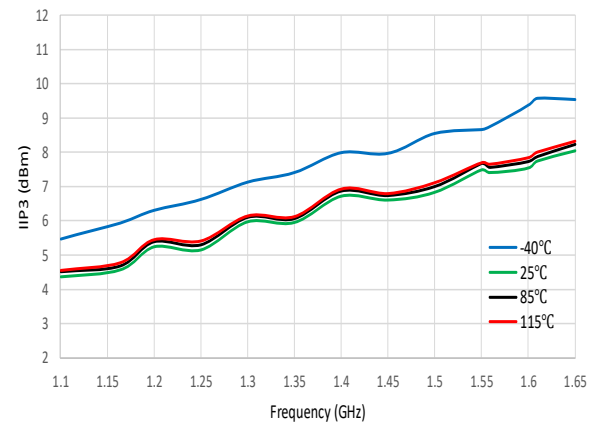

Figure 64. IIP3 vs. Frequency

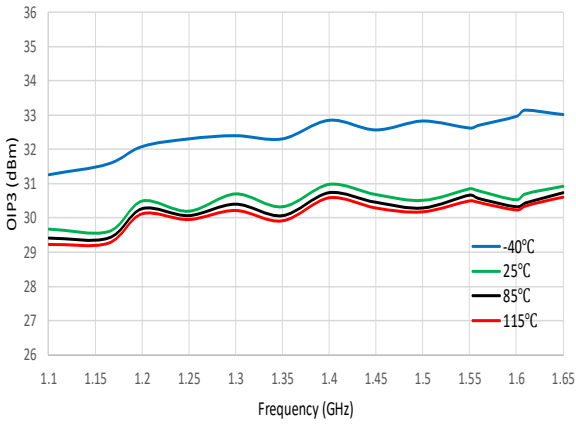

Figure 65. OIP3 vs. Frequency

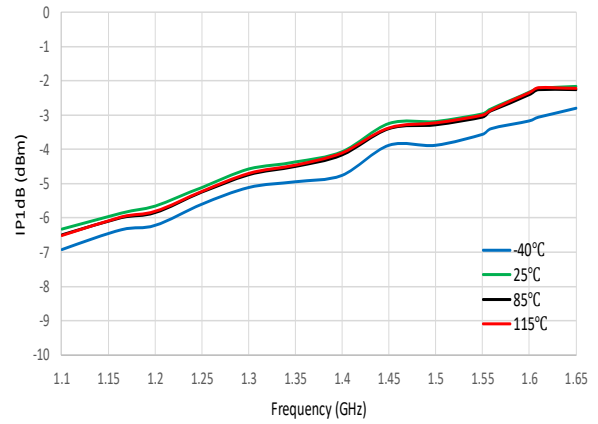

Figure 66. IP1dB vs. Frequency

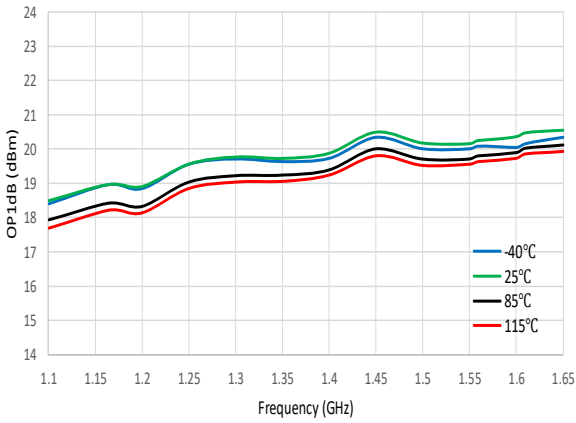

Figure 67. OP1dB vs. Frequency

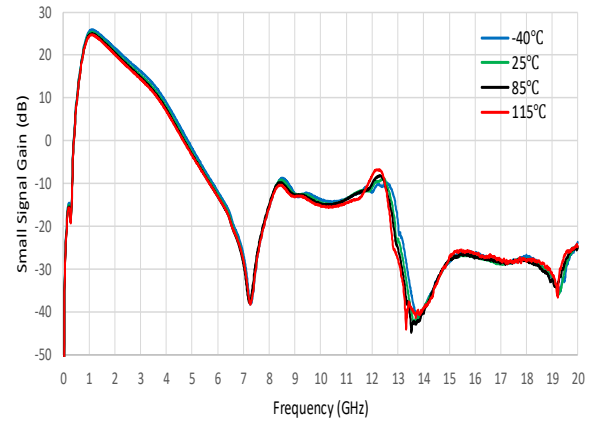

Figure 68. Small Signal Gain vs. Frequency

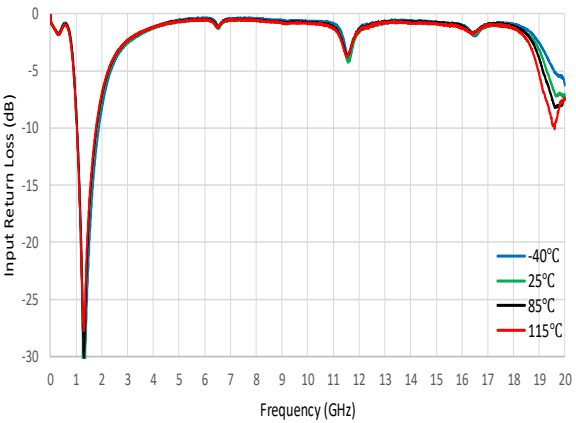

Figure 69. Input Return Loss vs. Frequency

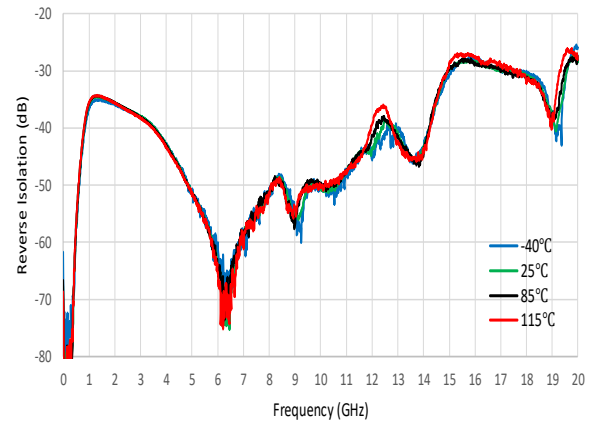

Figure 70. Reverse Isolation vs. Frequency

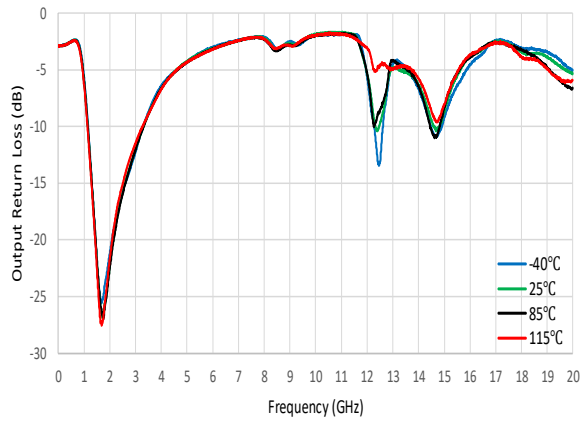

Figure 71. Output Return Loss vs. Frequency

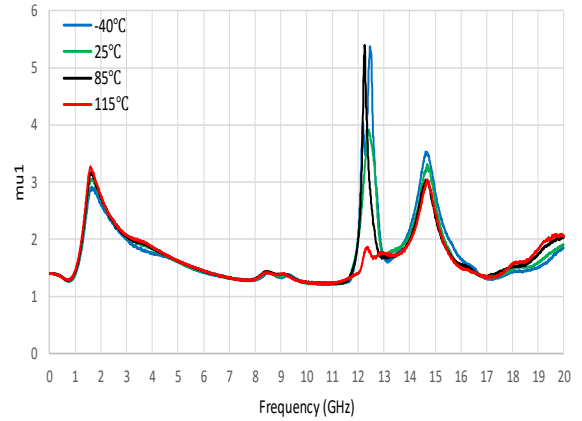

Figure 72. Stability Factor, μ_1 vs. Frequency

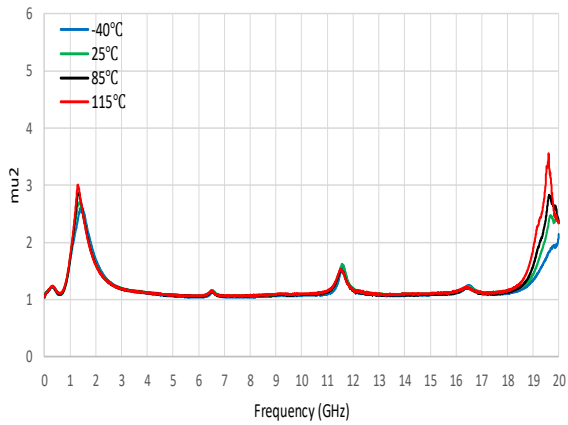
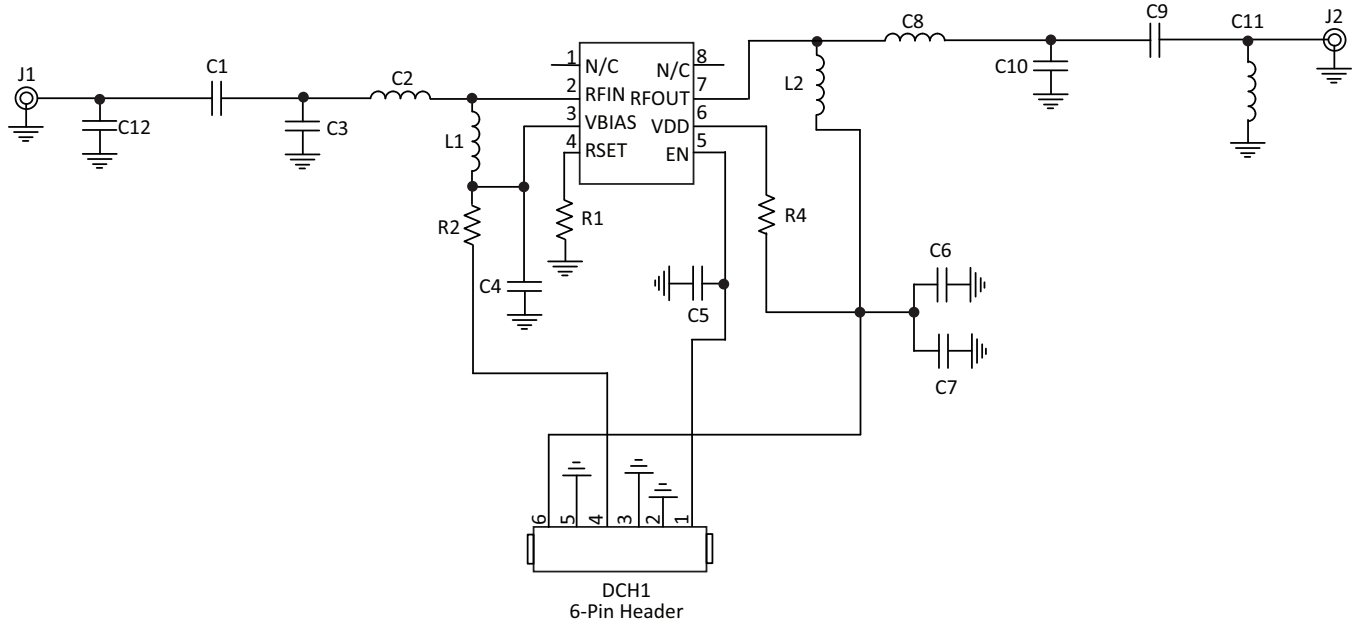

Figure 73. Stability Factor, μ_2 vs. Frequency

Evaluation Board Description

An Evaluation Board (EVB) is used to test the performance of the SKY67183-396LF LNA. Bill of Materials (BOMs) optimized for 4200 to 4900 MHz, 3300 to 3800, 2300 to 2700 MHz, 1700 to 2200, and 1100 to 1650 MHz appear on the following pages. An EVB assembly diagram and layer details are also included in this data sheet.



*R2 is “Do Not Install” since this pin is internally connected.
 Vbias pin does not need to be externally connected to 5 V.

Figure 74. Evaluation Board Schematic

Table 10. Evaluation Board Bill of Materials for 4200 to 4900 MHz Tuning

Component	Value	Size	Part Number
C1	1.8 pF	0402	GJM1555C1H1R8BB01D
C2	0.8 nH	03015	LQW04AN0N8C00D
C3	0.4 pF	0402	GJM1555C1HR40WB01D
C4	DNI		
C5	DNI		
C6	DNI		
C7	4.7 uF	0402	GRM155C80J475MEAAD
C8	2.2 pF	0402	GRM1555C1H2R2BA01D
C9	0 Ω	0402	Not critical
C10	1.0 nH	0402	LQG15HS1N0S02D
C11	DNI		
C12	DNI		
L1	18 nH	0402	LQW15AN18NG8ZD
L2	6.2 nH	0402	LQG15HS6N2S02D
R1	8.2 kΩ	0201	Not critical
R2	DNI		
R4	100 Ω	0201	Not critical

Table 11. Evaluation Board Bill of Materials for 3300 to 3800 MHz Tuning

Component	Value	Size	Part Number
C1	1.8 pF	0402	GJM1555C1H1R8BB01
C2	1.8 nH	0402	LQW15AN1N8C00
C3	0.4 pF	0402	GJM1555C1HR40WB01D
C4	DNI		
C5	DNI		
C6	DNI		
C7	4.7 uF	0402	GRM155C80J475MEAAD
C8	5.6 pF	0402	GRM1555C1H5R6BA01D
C9	0 Ω	0402	Not critical
C10	1.8 nH	0402	LQG15HS1N8S02D
C11	DNI		
C12	DNI		
L1	12 nH	0402	LQW15AN12NG8ZD
L2	5.6 nH	0402	LQG15HS5N6S02D
R1	8.2 k Ω	0201	Not critical
R2	DNI		
R4	100	0201	Not critical

Table 12. Evaluation Board Bill of Materials for 2300 to 2700 MHz Tuning

Component	Value	Size	Part Number
C1	5.0 pF	0402	GJM1555C1H5R0BB01D
C2	2.7 nH	0402	LQW15AN2N7B8ZD
C3	0.4 pF	0402	GJM1555C1HR40WB01D
C4	10 pF	0402	GRM1555C1H100JA01D
C5	DNI		
C6	DNI		
C7	4.7 uF	0402	GRM155C80J475MEAAD
C8	22 pF	0402	GRM1555C1H220JA01
C9	1.8 pF	0402	GRM1555C1H1R8BA01D
C10	3.3 nH	0402	LQG15HS3N3S02D
C11	DNI		
C12	DNI		
L1	22 nH	0402	LQW15AN22NG8ZD
L2	5.6 nH	0402	LQG15HS5N6S02D
R1	8.2 k Ω	0201	Not critical
R2	DNI		
R4	100 Ω	0201	Not critical

Table 13. Evaluation Board Bill of Materials for 1700 to 2200 MHz Tuning

Component	Value	Size	Part Number
C1	5.0 pF	0402	GJM1555C1H5R0BB01D
C2	4.7 nH	0402	LQW15AN4N7B8ZD
C3	0.4 pF	0402	GJM1555C1HR40WB01D
C4	15 pF	0402	GRM1555C1H150JA01D
C5	DNI		
C6	DNI		
C7	4.7 uF	0402	GRM155C80J475MEAAD
C8	22 pF	0402	GRM1555C1H220JA01
C9	1.8 pF	0402	GRM1555C1H1R8BA01D
C10	6.2 nH	0402	LQG15HS6N2S02D
C11	300 Ω	0402	ERJ-2RKF3000C
C12	DNI		
L1	22 nH	0402	LQW15AN22NG8ZD
L2	5.6 nH	0402	LQG15HS5N6S02D
R1	8.2 kΩ	0201	ERJ-1GNF8201C
R2	DNI		
R4	100 Ω	0201	ERJ-1GNF1000C

Table 14. Evaluation Board Bill of Materials for 1100 to 1650 MHz Tuning

Component	Value	Size	Part Number
C1	22 pF	0402	GJM1555C1H220JB01
C2	5.8 nH	0402	LQW15AN5N8B800
C3	DNI		
C4	18 pF	0402	GRM1555C1H180JA01
C5	DNI		
C6	DNI		
C7	4.7 uF	0402	GRM155C80J475MEAAD
C8	2 pF	0402	GRM1555C1H2R0BA01
C9	2 nH	0402	LQG15HS2N0B02
C10	DNI		
C11	300 Ω	0402	ERJ-2RKF3000C
C12	DNI		
L1	15 nH	0402	LQW15AN15NG00
L2	5.6 nH	0402	LQG15HS5N6S02
R1	8.2 k Ω	0201	ERJ-1GNF8201C
R2	DNI		
R4	100 Ω	0201	ERJ-1GNF1000C

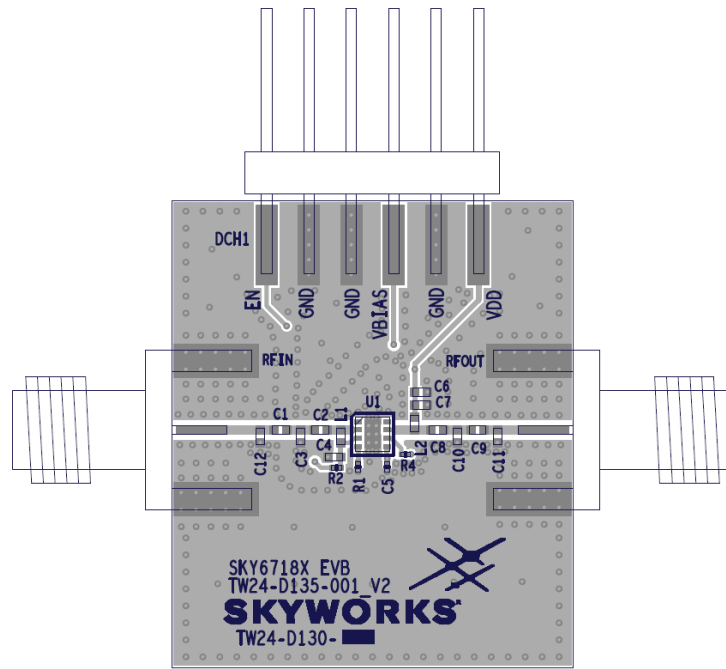

Figure 75. Evaluation Board Assembly Diagram

50-OHM TRACE	50-OHM TRACE	CROSS SECTION	NAME	THICKNESS	MATERIALS
$W=0.301\text{mm}$ $S=0.100\text{mm}$	TOL : +/- 5% $W=0.508\text{mm}$ CPW = 0.375mm		TMASK L1 DIELECTRIC L2 DIELECTRIC L3 DIELECTRIC L4 BMASK	0.020mm 0.047mm 0.254mm 0.018mm 0.900mm 0.018mm 0.254mm 0.047mm 0.020mm	SOLDER RESIST FINISHED Cu. RO4350B Cu-0.5oz. FR4 (4.34) Cu-0.5oz. FR4 (4.34) FINISHED Cu. SOLDER RESIST
$W=N/A$ $S=N/A$	$W=N/A$ CPW = N/A				
			TOTAL THICKNESS	1.578mm	TOL: +/- 10%

Figure 76. Evaluation Board Layer Details

Package and Handling Information

Instructions on the shipping container label regarding exposure to moisture after the container seal is broken must be followed. Otherwise, problems related to moisture absorption may occur when the part is subjected to high temperature during solder assembly.

The SKY67183-396LF is rated to Moisture Sensitivity Level 1 (MSL 1) at 260 °C. It can be used for lead or lead-free soldering. For additional information, refer to the Skyworks Application Note, “PCB Design & SMT Assembly/Rework Guidelines for MCM-L Packages,” document number 101752.

Care must be taken when attaching this product, whether it is done manually or in a production solder reflow environment. Product production quantities are shipped in a standard tape and reel format.

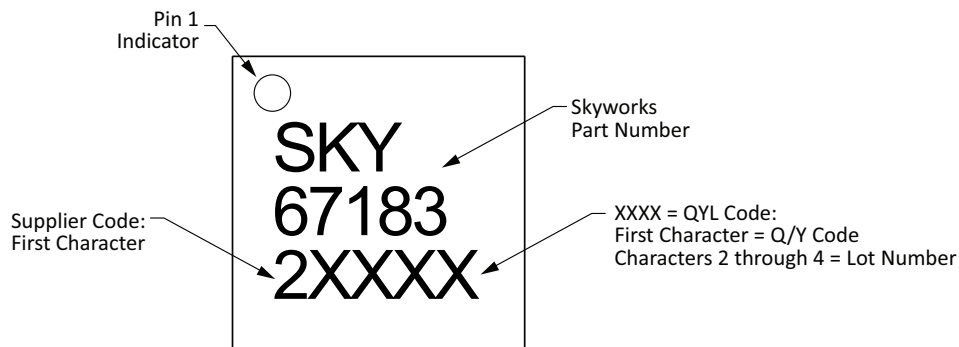
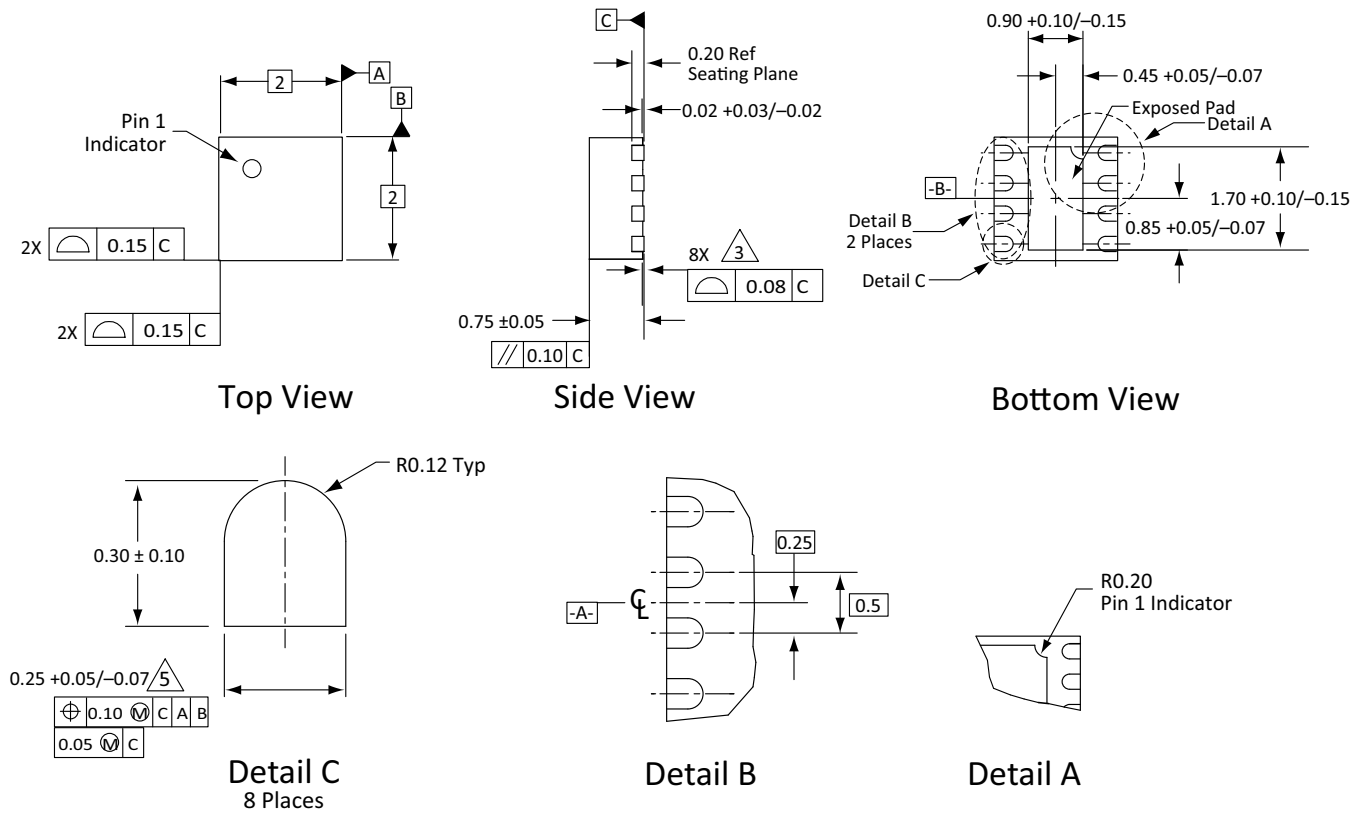

Figure 77. Typical Part Marking



Notes:

1. All measurements are in millimeters.
2. Dimensions and tolerances according to ASME Y14.5M-1994.
3. Coplanarity applies to the exposed heat sink ground pad as well as the terminals.
4. Plating requirement per source control drawing (SCD) 2504.
5. Dimension applies to metallized terminal and is measured between 0.15 mm and 0.30 mm from terminal tip.

Figure 78. Package Dimensions

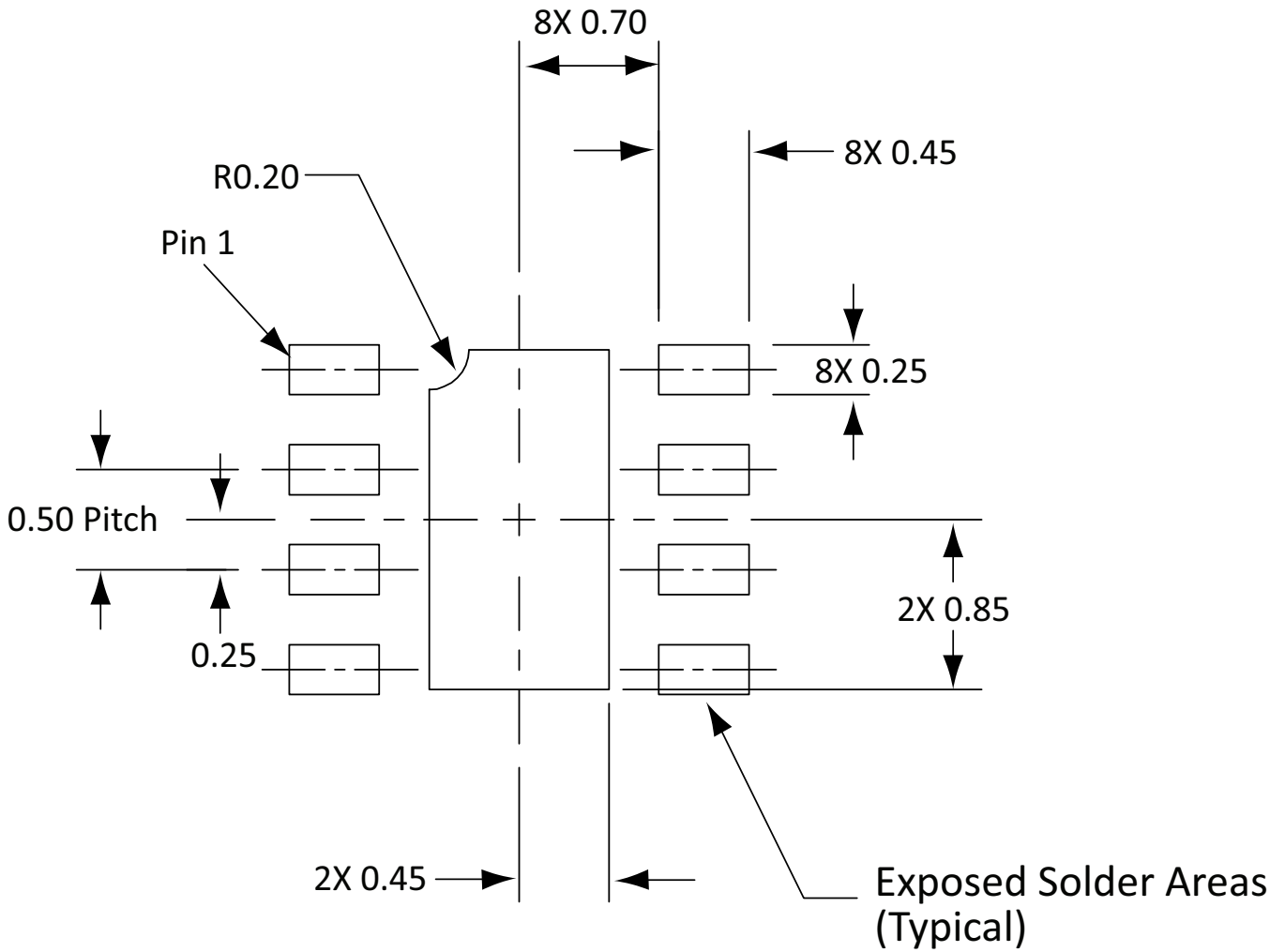

All dimensions are in millimeters

Figure 79. PCB Layout Footprint

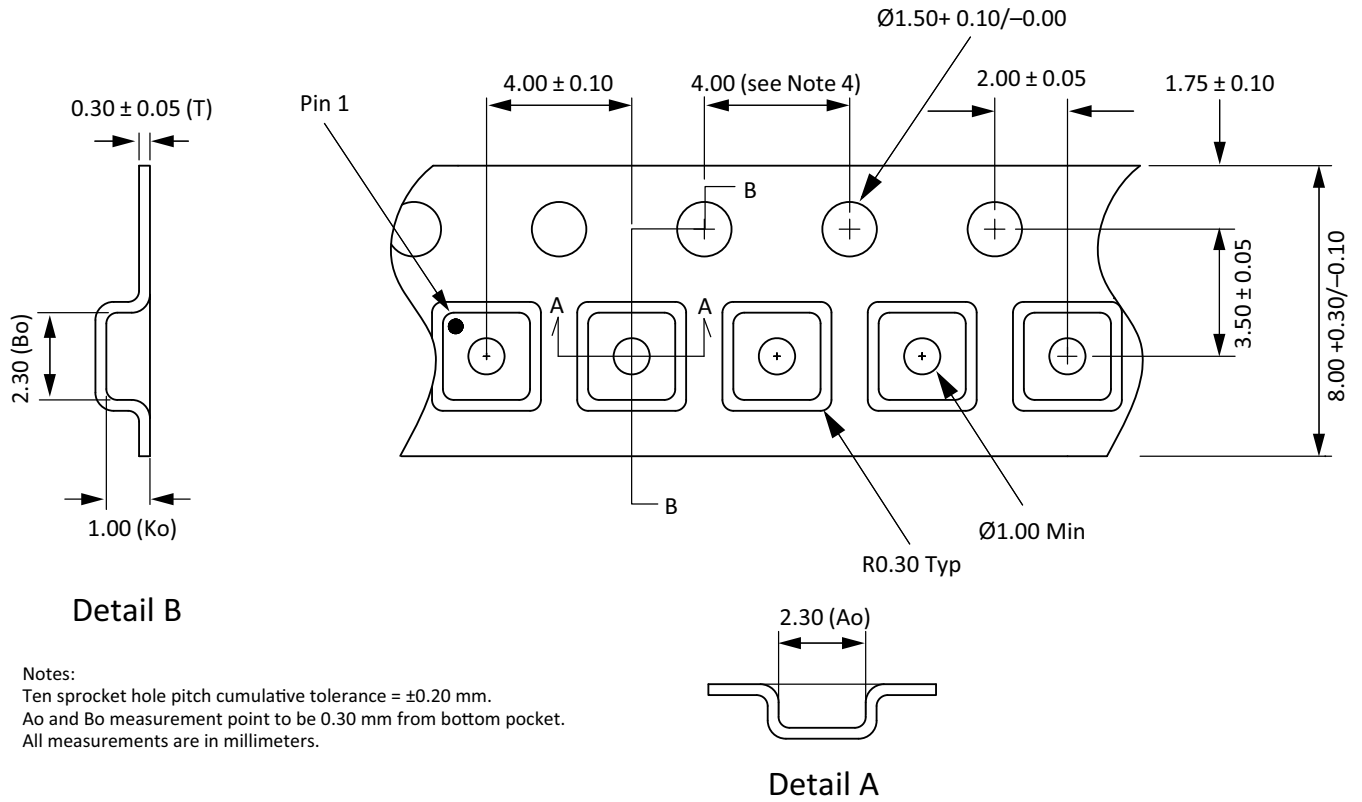

Figure 80. Tape and Reel Information

Ordering Information

Part Number	Description	Evaluation Board Part Numbers
SKY67183-396LF	400 to 6000 MHz Broadband Low-Noise Amplifier	SKY67183-396EK1, 4.2 to 4.9 GHz Tuning SKY67183-396EK2, 3.3 to 3.8 GHz Tuning SKY67183-396EK3, 2.3 to 2.7 GHz Tuning SKY67183-396EK4, 1.7 to 2.2 GHz Tuning SKY67183-396EK5, 1.1 to 1.65 GHz Tuning

Copyright © 2021-2022, 2025-2026, Skyworks Solutions, Inc. All Rights Reserved.

Information in this document is provided in connection with Skyworks Solutions, Inc., and its subsidiaries (“Skyworks”) products or services. These materials, including the information contained herein, are provided by Skyworks as a service to its customers and may be used for informational purposes only by the customer. Skyworks assumes no responsibility for errors or omissions in these materials or the information contained herein. Skyworks may change its documentation, products, services, specifications or product descriptions at any time, without notice. Skyworks makes no commitment to update the materials or information and shall have no responsibility whatsoever for conflicts, incompatibilities, or other difficulties arising from any future changes.

No license, whether express, implied, by estoppel or otherwise, is granted to any intellectual property rights by this document. Skyworks assumes no liability for any materials, products or information provided hereunder, including the sale, distribution, reproduction or use of Skyworks products, information or materials, except as may be provided in Skyworks’ Terms and Conditions of Sale.

THE INFORMATION IN THIS DOCUMENT AND THE MATERIALS AND PRODUCTS DESCRIBED THEREIN ARE PROVIDED “AS IS” WITHOUT WARRANTY OF ANY KIND, WHETHER EXPRESS, IMPLIED, STATUTORY, OR OTHERWISE, INCLUDING FITNESS FOR A PARTICULAR PURPOSE OR USE, MERCHANTABILITY, PERFORMANCE, QUALITY OR NON-INFRINGEMENT OF ANY INTELLECTUAL PROPERTY RIGHT; ALL SUCH WARRANTIES ARE HEREBY EXPRESSLY DISCLAIMED. SKYWORKS DOES NOT WARRANT THE ACCURACY OR COMPLETENESS OF THE INFORMATION, TEXT, GRAPHICS OR OTHER ITEMS CONTAINED WITHIN THESE MATERIALS. SKYWORKS SHALL NOT BE LIABLE FOR ANY DAMAGES, INCLUDING BUT NOT LIMITED TO ANY SPECIAL, INDIRECT, INCIDENTAL, STATUTORY, OR CONSEQUENTIAL DAMAGES, INCLUDING WITHOUT LIMITATION, LOST REVENUES OR LOST PROFITS THAT MAY RESULT FROM THE USE OF THE MATERIALS OR INFORMATION, WHETHER OR NOT THE RECIPIENT OF MATERIALS HAS BEEN ADVISED OF THE POSSIBILITY OF SUCH DAMAGE.

Skyworks products are not designed, intended, authorized, or warranted for use or inclusion in life support or life endangering applications, devices, or systems where failure or inaccuracy might cause death or personal injury. Skyworks customers agree not to use or sell the Skyworks products for such applications, and further agree to, without limitation, fully defend, indemnify, and hold harmless Skyworks and its agents from and against any and all actions, suits, proceedings, costs, expenses, damages, and liabilities including attorneys’ fees arising out of or in connection with such improper use or sale.

Skyworks assumes no liability for applications assistance, customer product design, or damage to any equipment resulting from the use of Skyworks products outside of Skyworks’ published specifications or parameters. Customers are solely responsible for their products and applications using the Skyworks products.

“Skyworks” and the Skyworks Starburst logo are registered trademarks of Skyworks Solutions, Inc., in the United States and other countries. Third-party brands and names are for identification purposes only and are the property of their respective owners. Additional information, including relevant terms and conditions, posted at www.skyworksin.com, are incorporated by reference.